

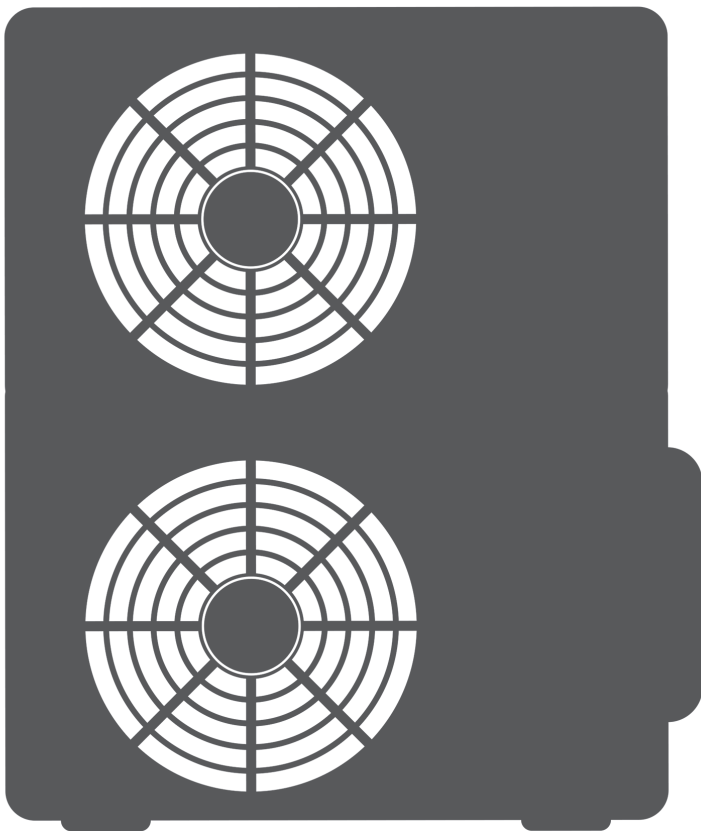

AIR CONDITIONING SYSTEMS

AIR TO WATER HEAT PUMPS - MONOBLOCK

- ENGINEERING DATABOOK



MODELS:
ATM18~30T



CONTENTS

Part 1 General Information.....	3
Part 2 Engineering Data	19
Part 3 Installation and Field Settings.....	39

Part 1

General Information

1 Matrix Mono System.....	4
2 Unit Capacities	6
3 Nomenclature	6
4 System Design and Unit Selection	7
5 Typical Applications	9

1 Matrix Mono System

1.1 System Schematic

Figure 1-1.1: System schematic

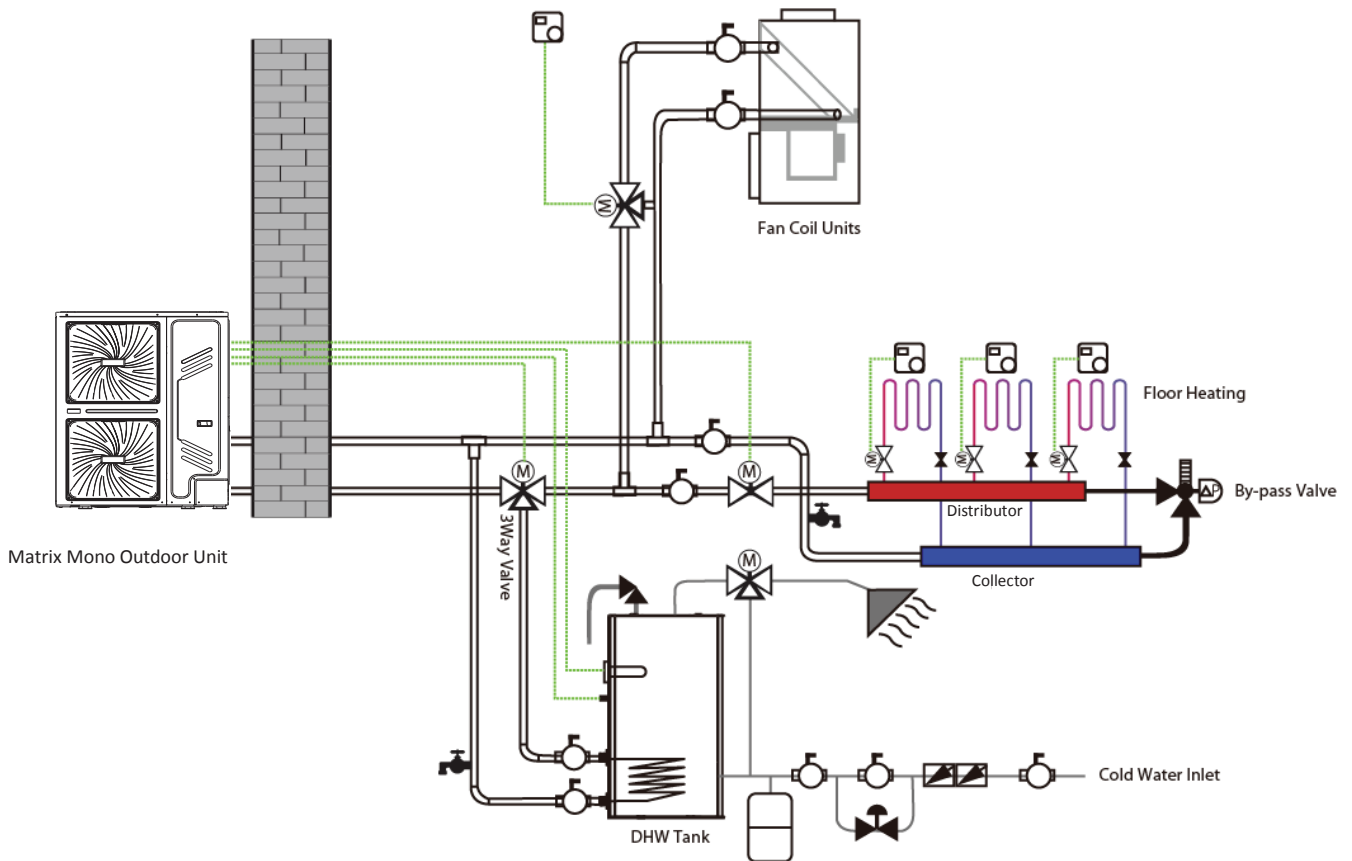

Matrix Mono is an integrated air to water heat pump system which is one-stop solution for space heating, space cooling and domestic hot water. The outdoor heat pump system extracts heat from the outdoor air and transfers this heat through refrigerant piping to the plate heat exchanger in the hydronic system. The heated water in the hydronic system circulates to low temperature heat emitters (floor heating loops or low temperature radiators) to provide space heating, and to the domestic hot water tank to provide domestic hot water. The 4-way valve in the outdoor unit can reverse the refrigerant cycle so that the hydronic system can provide chilled water for cooling using fan coil units.

The heating capacity of heat pumps decreases with ambient temperature dropping. Matrix Mono can be equipped with a backup electric heater to provide additional heating capacity for use during extremely cold weather when the heat pump capacity is insufficient. The backup electric heater also serves as a backup in case of heat pump malfunction and for anti-freeze protection of the outside water piping in winter.

1.2 System Configurations

Matrix Mono can be configured to run with the electric heater either enabled or disabled and can also be used in conjunction with an auxiliary heat source such as a boiler.

The chosen configuration affects the size of heat pump that is required. Three typical configurations are described below. Refer to Figure 1-1.2.

Configuration 1: Heat pump only

- The heat pump covers the required capacity and no extra heating capacity is necessary.
- Requires selection of larger capacity heat pump and implies higher initial investment.
- Ideal for new construction in projects where energy efficiency is paramount.

Configuration 2: Heat pump and backup electric heater

- Heat pump covers the required capacity until the ambient temperature drops below the point at which the heat pump is able to provide sufficient capacity. When the ambient temperature is below this equilibrium point (as shown in Figure 1-1.2), the backup electric heater supplies the required additional heating capacity.
- Best balance between initial investment and running costs, results in lowest lifecycle cost.
- Ideal for new construction.

Configuration 3: Heat pump with auxiliary heat source

- Heat pump covers the required capacity until the ambient temperature drops below the point at which the heat pump is able to provide sufficient capacity. When the ambient temperature is below this equilibrium point (as shown in Figure 1-1.2), depending on the system settings, either the auxiliary heat source supplies the required additional heating capacity or the heat pump does not run and the auxiliary heat source covers the required capacity.
- Enables selection of lower capacity heat pump.
- Ideal for refurbishments and upgrades.

Figure 1-1.2: System configurations

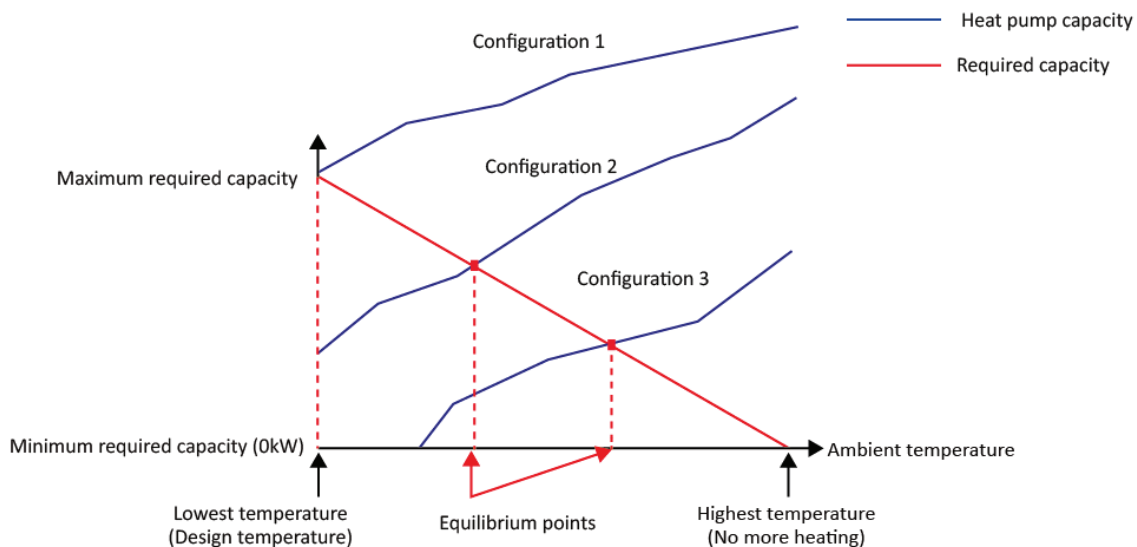

2 Unit Capacities

Table 1-2.1: Unit capacities range and appearances

Capacity	18kW	22kW	26kW	30kW
Model	18T	22T	26T	30T
ATM				
Appearance				

3 Nomenclature

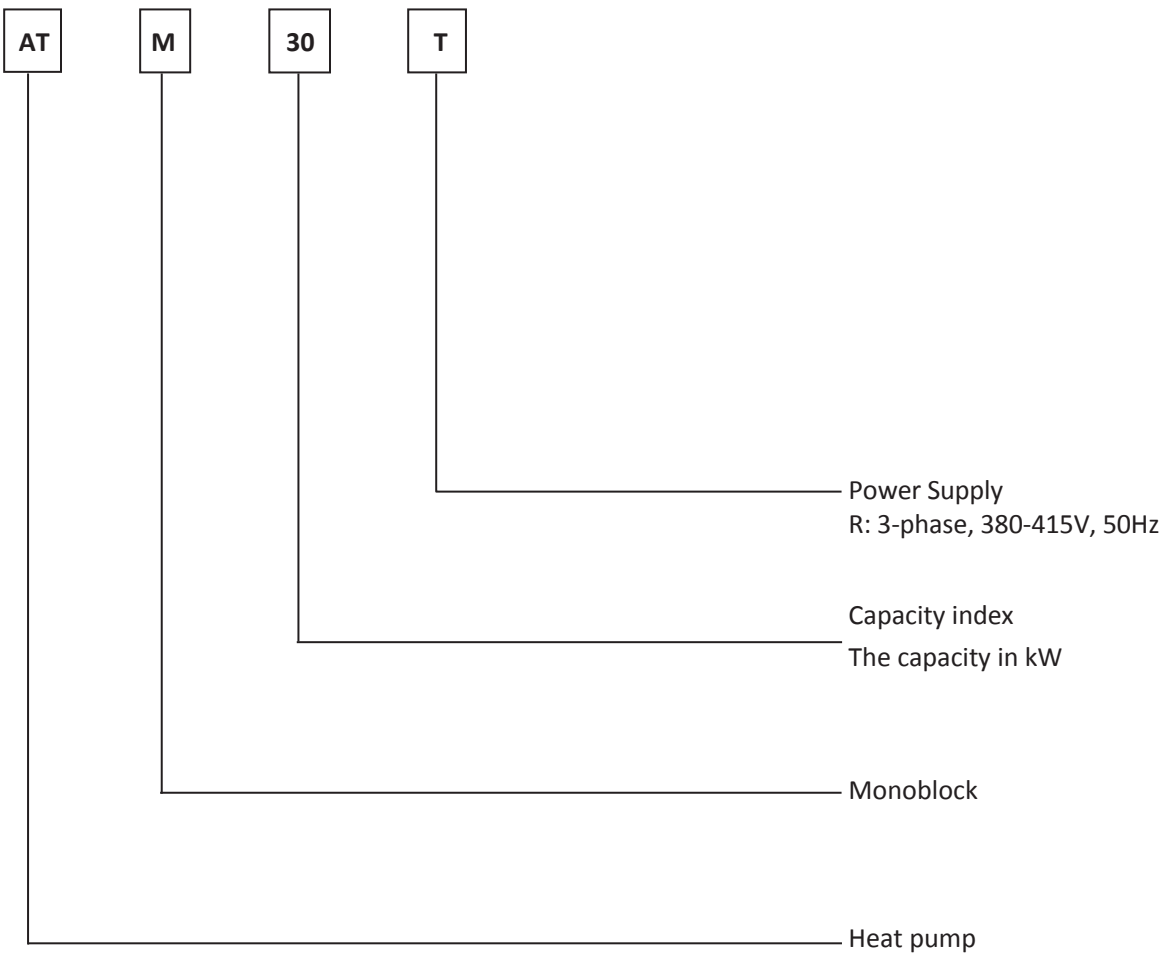

4 System Design and Unit Selection

4.1 Selection Procedure

Step 1: Total heat load calculation

Calculate conditioned surface area
 Select the heat emitters (type, quantity, water temperature and heat load)

Step 2: System configuration

Decide whether to include AHS and set AHS's switching temperature
 Decide whether backup electric heater is enabled or disabled

Step 3: Selection of outdoor units

Determine required total heat load on outdoor units
 Set capacity safety factor
 Select power supply

Provisionally select Matrix Mono unit capacity based on nominal capacity

Correct capacity of the outdoor units for the following items:
 Outdoor air temperature / Outdoor humidity / Water outlet temperature¹ /
 Altitude / Anti-freeze fluid

Is corrected Matrix Mono unit capacity \geq Required total heat load on outdoor units²

Yes
 Matrix Mono system selection is complete

No
 Select a larger model or enable backup electric heater operation

Part 1 - General Information

Notes:

1. If the required water temperatures of the heat emitters are not all the same, the MatrixMono's outlet water temperature setting should be set at the highest of the heat emitter required water temperatures. If the water outlet design temperature falls between two temperatures listed in the outdoor unit's capacity table, calculate the corrected capacity by interpolation.
2. Select Mono units which should satisfy both total heating and cooling load requirements.

4.2 Matrix Leaving Water Temperature (LWT) Selection

The recommended design LWT ranges for different types of heat emitter are:

- For floor heating: 30 to 35°C
- For fan coil units: 30 to 45°C
- For low temperature radiators: 40 to 50°C

4.3 Optimizing System Design

To get the most comfort with the lowest energy consumption with Matrix it is important to take account of the following considerations:

- Choose heat emitters that allow the heat pump system to operate at as low a hot water temperature as possible whilst still providing sufficient heating.
- Make sure the correct weather dependency curve is selected to match the installation environment (building structure, climate) as well as ender user's demands.
- Connecting room thermostats (field supplied) to the hydronic system helps prevent excessive space heating by stopping the outdoor unit and circulator pump when the room temperature is above the thermostat set point.

5 Typical Applications

5.1 Space Heating

The room thermostat is used as a switch. When there is a heating request from the room thermostat, the Mono unit operates to achieve the target water temperature set on the user interface. When the room temperature reaches the thermostat's set temperature, the unit stops.

Figure 1-5.1: Space heating

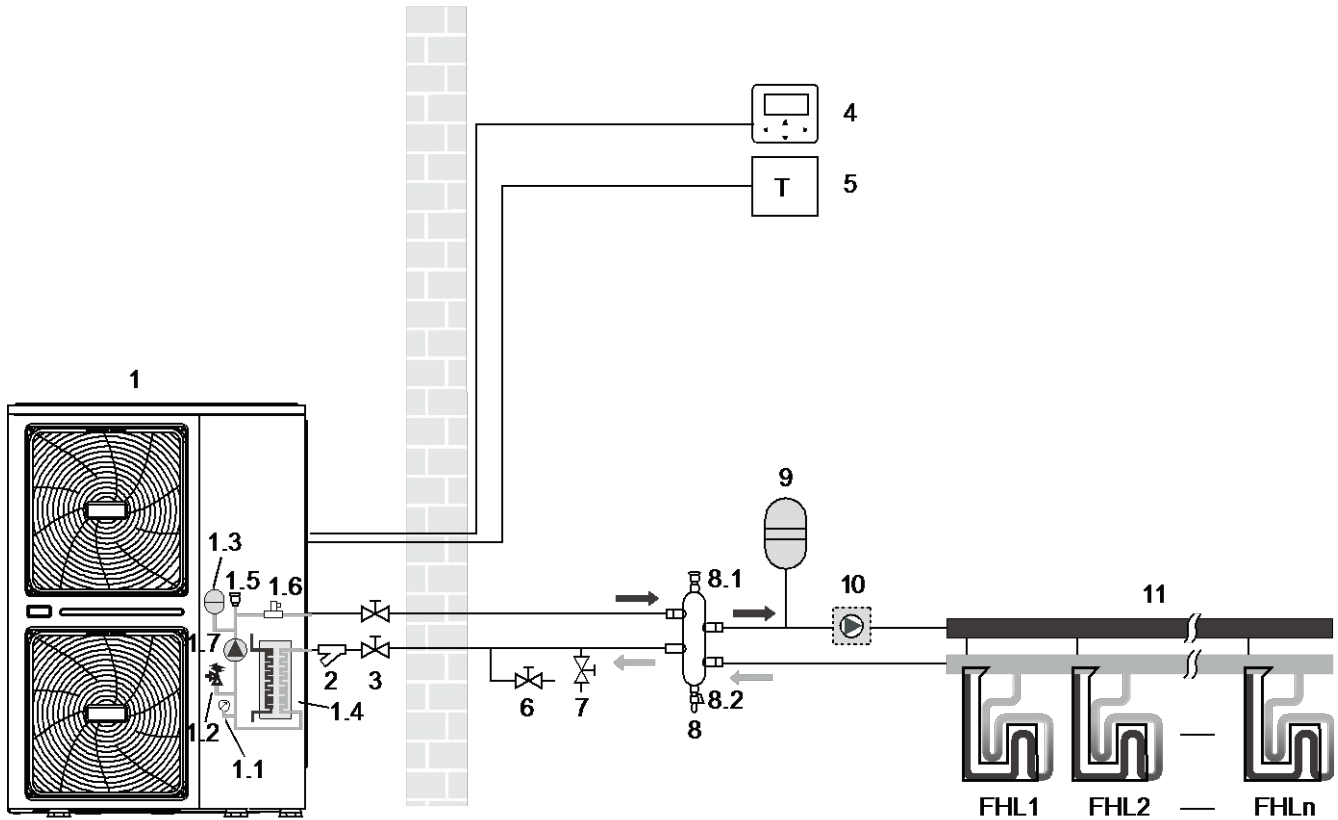

Table 1-5.1: Space heating

Legend			
1	Outdoor unit	5	Room thermostat (field supplied)
1.1	Manometer	6	Drain valve (field supplied)
1.2	Pressure relief valve	7	Fill valve (field supplied)
1.3	Expansion vessel	8	Balance tank (field supplied)
1.4	Plate heat exchanger	8.1	Air purge valve
1.5	Air purge valve	8.2	Drain valve
1.6	Flow switch	9	Expansion vessel (field supplied)
1.7	P _i : Circulation pump inside the unit	10	P _o : Outside circulation pump (field supplied)
2	Y-shape filter	11	Collector / Distributor (field supplied)
3	Stop valve (field supplied)	FHL 1...n	Floor heating loop (field supplied)
4	Wired controller		

Notes:

1. The example is just for application illustration; please confirm the exact installation method according to the installation manual.

5.2 Space Heating and DHW with solar system

Space heating without room thermostat connected to the unit. Domestic hot water tank is connected to the unit, and the tank is with solar heating system. Solar water pump is controlled by T_{solar} temperature sensor. Balance tank temperature sensor is used to control on/off of heat pump. Once the heat pump stops, internal pump stops to save energy and then balance tank provides hot water for space heating. In addition, balance tank temperature control can meet both space heating and domestic hot water needs at the same time.

Figure 1-5.2: Space heating and DHW with solar system

Space heating without room thermostat connected to the unit. Domestic hot water tank is connected to the unit, and the tank is with solar heating system.

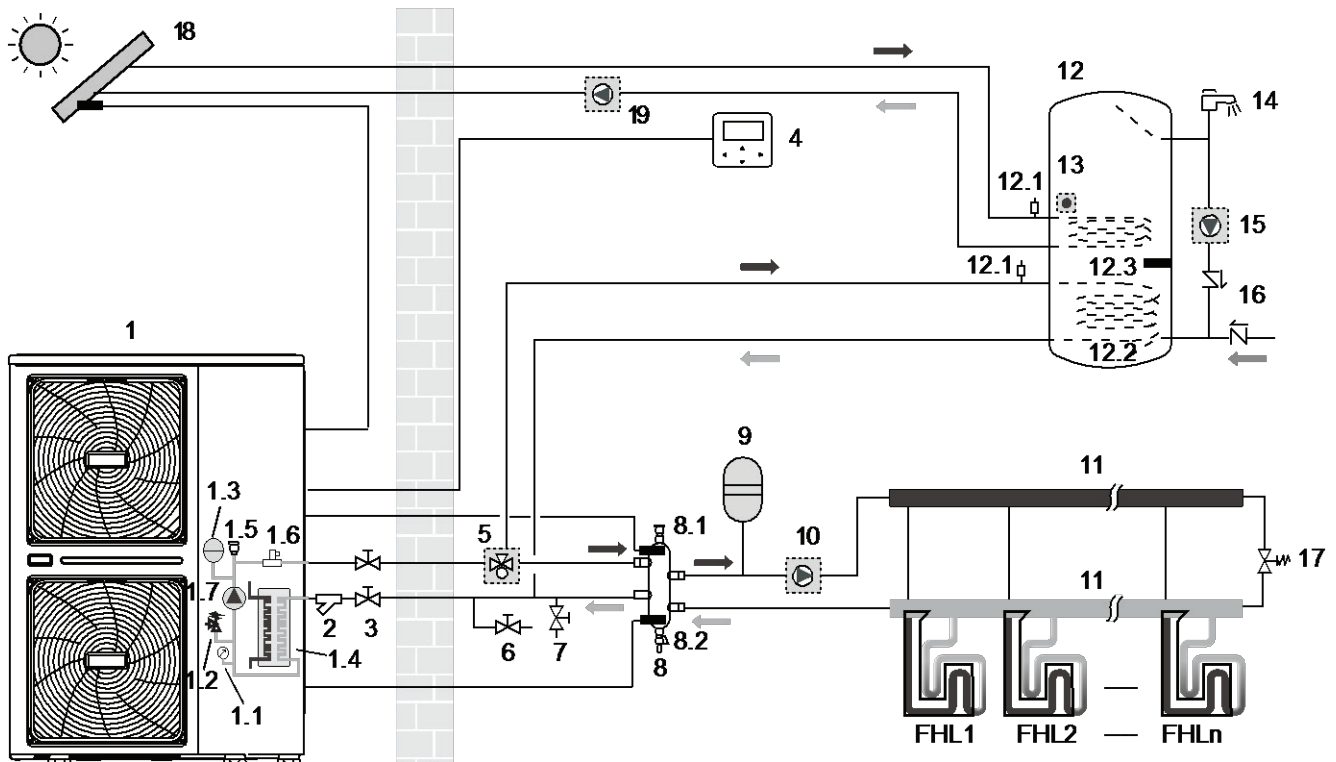

Table 1-5.2: Space heating and DHW with solar system

Legend			
1	Outdoor unit	8.2	Drain valve
1.1	Manometer	9	Expansion vessel (field supplied)
1.2	Pressure relief valve	10	P _o : Outside circulation pump (field supplied)
1.3	Expansion vessel	11	Collector / Distributor (field supplied)
1.4	Plate heat exchanger	12	Domestic hot water tank (field supplied)
1.5	Air purge valve	12.1	Air purge valve
1.6	Flow switch	12.2	Heat exchanger coil
1.7	P _i : Circulation pump inside the unit	12.3	Booster heater
2	Y-shape filter	13	T ₅ : Temperature sensor
3	Stop valve (field supplied)	14	Hot water tap(field supplied)
4	Wired controller	15	P _d : Cycle hot water pump (field supplied)
5	SV1: 3-way valve (field supplied)	16	One way valve(field supplied)
6	Drain valve (field supplied)	17	Bypass valve(field supplied)
7	Fill valve (field supplied)	18	Solar heater(field supplied)
8	Balance tank (field supplied)	19	P _s : Solar pump(field supplied)
8.1	Air purge valve	FHL 1...n	Floor heating loop (field supplied)

Notes:

- The example is just for application illustration; please confirm the exact installation method according to the installation manual.

5.3 Space Heating, Cooling and DHW with solar system

Space cooling and heating application with a room thermostat suitable for heating/cooling changeover when connected to the unit. Heating is provided through floor heating loops and fan coil units. Cooling is provided through the fan coil units only. Domestic hot water is provided through the domestic hot water tank which is connected to the unit.

Figure 1-5.3: Space heating, cooling and DHW with solar system

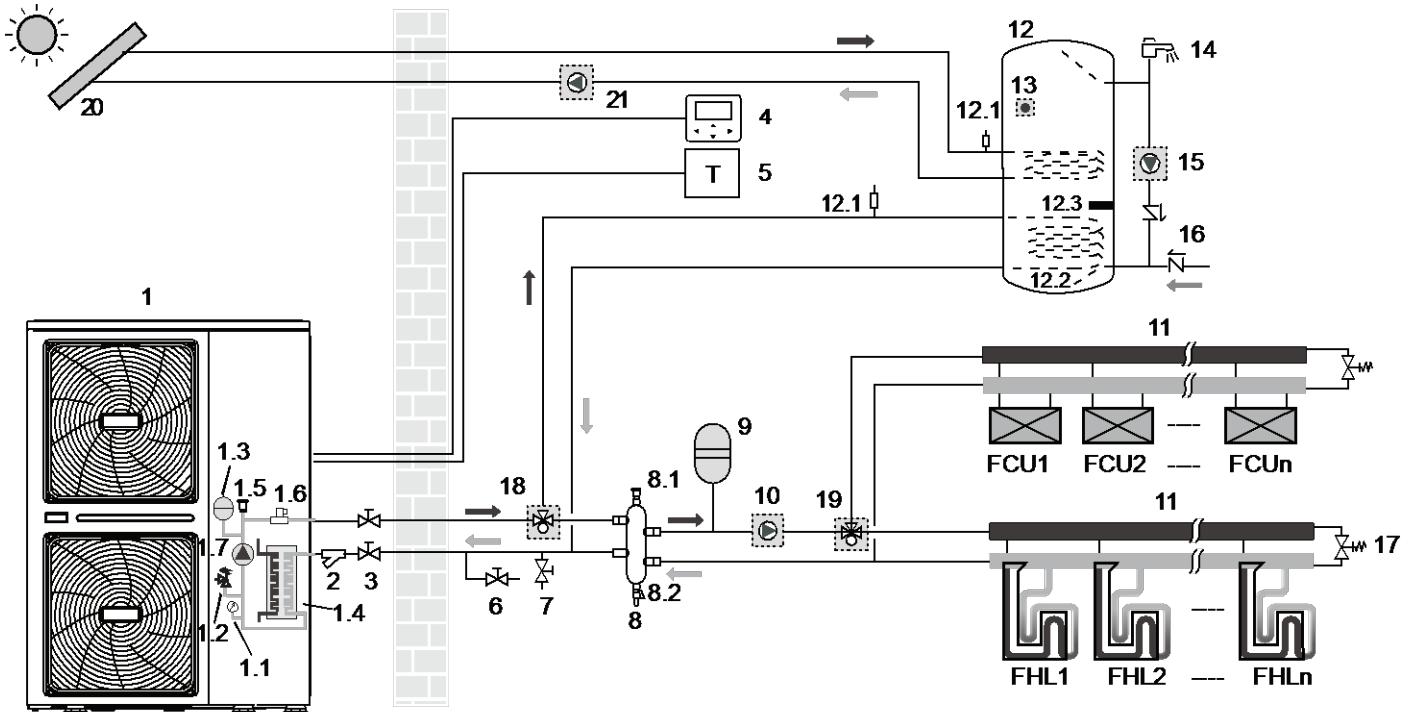

Table 1-5.3: Space heating, cooling and DHW with solar system

Legend			
1	Outdoor unit	10	P_o: Outside circulation pump (field supplied)
1.1	Manometer	11	Collector / Distributor (field supplied)
1.2	Pressure relief valve	12	Domestic hot water tank (field supplied)
1.3	Expansion vessel	12.1	Air purge valve
1.4	Plate heat exchanger	12.2	Heat exchanger coil
1.5	Air purge valve	12.3	Booster heater
1.6	Flow switch	13	T5: Temperature sensor
1.7	P_i: Circulation pump inside the unit	14	Hot water tap(field supplied)
2	Y-shape filter	15	P_d: Cycle hot water pump(field supplied)
3	Stop valve (field supplied)	16	One way valve(field supplied)
4	Wired controller	17	Bypass valve(field supplied)
5	Room thermostat (field supplied)	18	SV1: 3-way valve(field supplied)
6	Drain valve (field supplied)	19	SV2: 3-way valve (field supplied)
7	Fill valve (field supplied)	20	Solar heater(field supplied)
8	Balance tank (field supplied)	21	P_s: Solar pump(field supplied)
8.1	Air purge valve	FHL 1...n	Floor heating loop (field supplied)
8.2	Drain valve	FCU 1...n	Fan coil units(field supplied)
9	Expansion vessel (field supplied)		

Notes:

1. The example is just for application illustration; please confirm the exact installation method according to the installation manual.

5.4 AHS provides heat for space heating

Space heating application by either the unit or by AHS connected in the system.
 If AHS only provides heat for space heating, AHS must be integrated in the piping work.

Figure 1-5.4: AHS provides heat for space heating

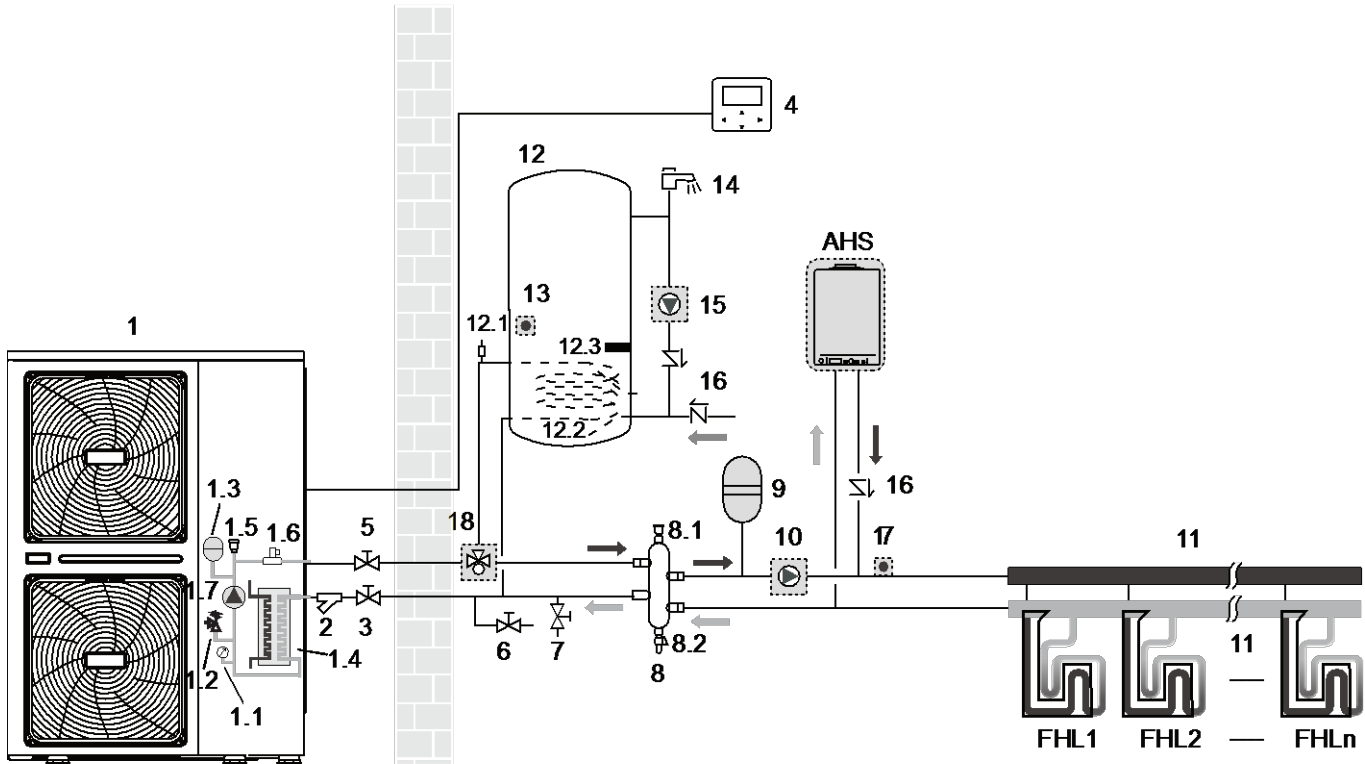

Table 1-5.4: AHS provides heat for space heating

Legend			
1	Outdoor unit	8.2	Drain valve
1.1	Manometer	9	Expansion vessel (field supplied)
1.2	Pressure relief valve	10	P_o: Outside circulation pump (field supplied)
1.3	Expansion vessel	11	Collector / Distributor (field supplied)
1.4	Plate heat exchanger	12	Domestic hot water tank (field supplied)
1.5	Air purge valve	12.1	Air purge valve
1.6	Flow switch	12.2	Heat exchanger coil
1.7	P_i: Circulation pump inside the unit	12.3	Booster heater
2	Y-shape filter	13	T5: Temperature sensor
3	Stop valve (field supplied)	14	Hot water tap(field supplied)
4	Wired controller	15	P_d: Cycle hot water pump(field supplied)
5	Stop valve (field supplied)	16	One way valve(field supplied)
6	Drain valve (field supplied)	17	T1: Outlet water temperature sensor(field supplied)
7	Fill valve (field supplied)	18	SV1: 3-way valve (field supplied)
8	Balance tank (field supplied)	FHL 1...n	Floor heating loop (field supplied)
8.1	Air purge valve		

Notes:

1. The example is just for application illustration; please confirm the exact installation method according to the installation manual.

5.5 AHS provides heat for space heating and DHW

Space heating application by either the unit or by AHS connected in the system. Bivalent operation is possible for both space heating operation and domestic water heating operation. If AHS is also providing heat for domestic hot water, AHS can be integrated in the piping work. In this condition, the unit can send ON/OFF signal to AHS in heating mode, but AHS control itself in DHW mode.

Figure 1-5.5: AHS provides heat for space heating and DHW

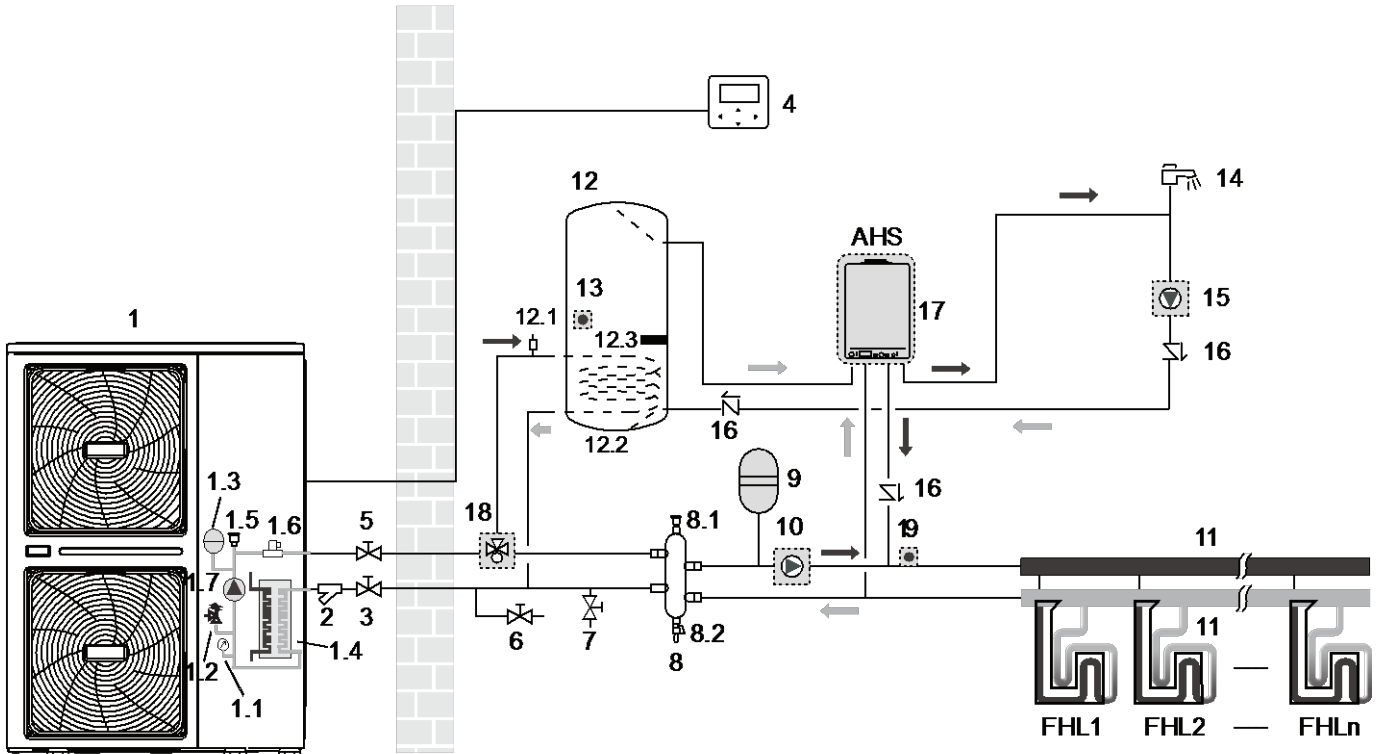

Table 1-5.5: AHS provides heat for space heating and DHW

Legend			
1	Outdoor unit	8.2	Drain valve
1.1	Manometer	9	Expansion vessel (field supplied)
1.2	Pressure relief valve	10	P_o: Outside circulation pump (field supplied)
1.3	Expansion vessel	11	Collector / Distributor (field supplied)
1.4	Plate heat exchanger	12	Domestic hot water tank (field supplied)
1.5	Air purge valve	12.1	Air purge valve
1.6	Flow switch	12.2	Heat exchanger coil
1.7	P_i: Circulation pump inside the unit	12.3	Booster heater
2	Y-shape filter	13	T5: Temperature sensor
3	Stop valve (field supplied)	14	Hot water tap(field supplied)
4	Wired controller	15	P_d: Cycle hot water pump(field supplied)
5	Stop valve (field supplied)	16	One way valve(field supplied)
6	Drain valve (field supplied)	17	Additional heat source(field supplied)
7	Fill valve (field supplied)	18	SV1: 3-way valve (field supplied)
8	Balance tank (field supplied)	19	T1: Outlet water temperature sensor(field supplied)
8.1	Air purge valve	FHL 1...n	Floor heating loop (field supplied)

Notes:

1. The example is just for application illustration; please confirm the exact installation method according to the installation manual.

Matrix Mono

5.6 AHS provides heat for DHW

Figure 1-5.6: AHS provides heat for DHW

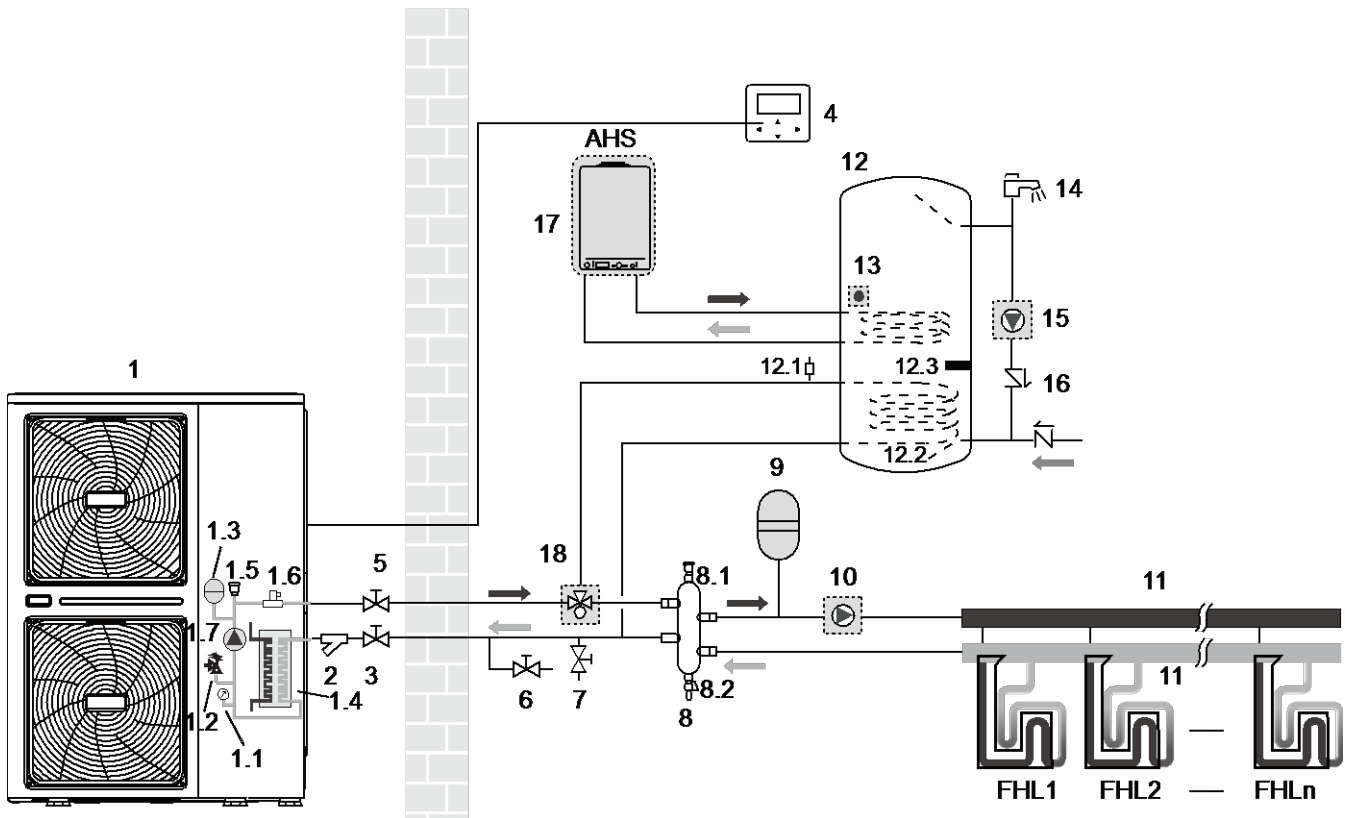

Table 1-5.6: AHS provides heat for DHW

Legend			
1	Outdoor unit	8.2	Drain valve
1.1	Manometer	9	Expansion vessel (field supplied)
1.2	Pressure relief valve	10	P_o: Outside circulation pump (field supplied)
1.3	Expansion vessel	11	Collector / Distributor (field supplied)
1.4	Plate heat exchanger	12	Domestic hot water tank (field supplied)
1.5	Air purge valve	12.1	Air purge valve
1.6	Flow switch	12.2	Heat exchanger coil
1.7	P_i: Circulation pump inside the unit	12.3	Booster heater
2	Y-shape filter	13	T5: Temperature sensor
3	Stop valve (field supplied)	14	Hot water tap(field supplied)
4	Wired controller	15	P_d: Cycle hot water pump(field supplied)
5	Stop valve (field supplied)	16	One way valve(field supplied)
6	Drain valve (field supplied)	17	Additional heat source(field supplied)
7	Fill valve (field supplied)	18	SV1: 3-way valve (field supplied)
8	Balance tank (field supplied)	FHL 1...n	Floor heating loop (field supplied)
8.1	Air purge valve		

Notes:

1. The example is just for application illustration; please confirm the exact installation method according to the installation manual.

5.7 Dual setpoint function application with two room thermostats

Space heating with two room thermostats application is through floor heating loops and fan coil units. The floor heating loops and fan coil units require different operating water temperature. The floor heating loops require a lower water temperature in heating mode compared to fan coil units. To achieve these two set points, a mixing station is used to adapt the water temperature according to requirements of the floor heating loops. The fan coil units are directly connected to the unit water circuit and the floor heating loops are after the mixing station. The mixing station is controlled by the unit (or field supply, controls by itself). With the help of hydronic adapter board(optional) which is connected between hydronic box and thermostats, maximum 8 thermostats for 8 rooms are available to control heat pump, which greatly improves the operation convenience.

Figure 1-5.7: Dual setpoint function application with two room thermostats

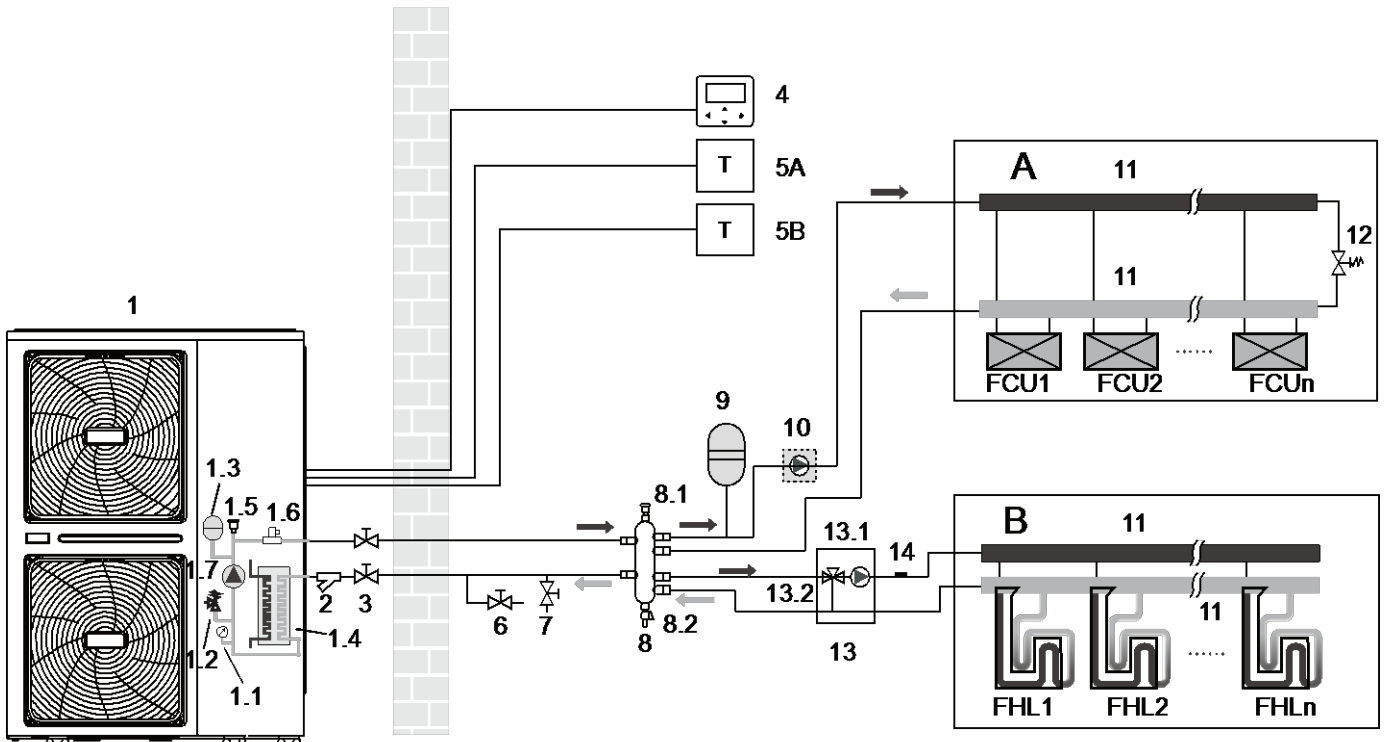

Part 1 - General Information

Table 1-5.7: Dual setpoint function application with two room thermostats

Legend			
1	Outdoor unit	7	Fill valve (field supplied)
1.1	Manometer	8	Balance tank (field supplied)
1.2	Pressure relief valve	8.1	Air purge valve
1.3	Expansion vessel	8.2	Drain valve
1.4	Plate heat exchanger	9	Expansion vessel (field supplied)
1.5	Air purge valve	10	P_o: Outside circulation pump (field supplied)
1.6	Flow switch	11	Collector / Distributor (field supplied)
1.7	P_i: Circulation pump inside the unit	12	Bypass valve (field supplied)
2	Y-shape filter	13	Mixing station(field supplied)
3	Stop valve (field supplied)	13.1	P_c: zone 2 pump (field supplied)
4	Wired controller	13.2	SV3: 3-way valve (field supplied)
5A	Room thermostat for zone 1 (field supply)	14	Tw2: Zone 2 water flow temp.(field supplied)
5B	Room thermostat for zone 2 (field supply)	FHL 1...n	Floor heating loop (field supplied)
6	Drain valve(field supplied)	FCU 1...n	Fan coil units (field supplied)

Notes:

1. The example is just for application illustration; please confirm the exact installation method according to the installation manual.

5.8 Dual setpoint function application without thermostats

Heating is provided through floor heating loops and fan coil units. The floor heating loops and fan coil units require different operating water temperatures. The floor heating loops require a lower water temperature in heating mode compared to fan coil units. To achieve these two set points, a mixing station is used to adapt the water temperature according to requirements of the floor heating loops. The fan coil units are directly connected to the unit water circuit and the floor heating loops are after the mixing station. The mixing station is controlled by the unit (or field supply, controls by itself).

Figure 1-5.8: Dual setpoint function application without thermostats

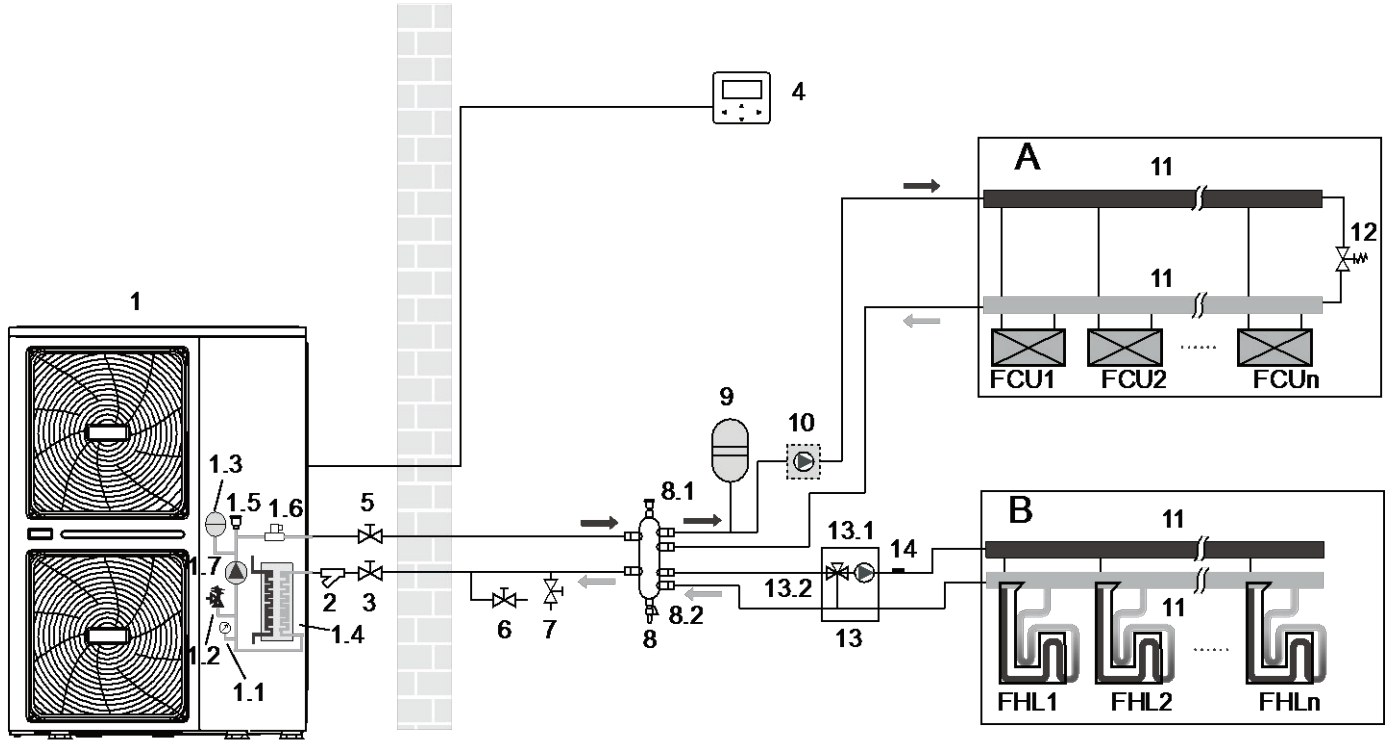

Table 1-5.8: Dual setpoint function application without thermostats

Legend			
1	Outdoor unit	8	Balance tank (field supplied)
1.1	Manometer	8.1	Air purge valve
1.2	Pressure relief valve	8.2	Drain valve
1.3	Expansion vessel	9	Expansion vessel (field supplied)
1.4	Plate heat exchanger	10	P_o: Outside circulation pump (field supplied)
1.5	Air purge valve	11	Collector / Distributor (field supplied)
1.6	Flow switch	12	Bypass valve (field supplied)
1.7	P_i: Circulation pump inside the unit	13	Mixing station(field supplied)
2	Y-shape filter	13.1	P_c: zone 2 pump (field supplied)
3	Stop valve (field supplied)	13.2	SV3: 3-way valve (field supplied)
4	Wired controller	14	Tw2: Zone 2 water flow temp.(field supplied)
5	Stop valve (field supplied)	FHL 1...n	Floor heating loop (field supplied)
6	Drain valve(field supplied)	FCU 1...n	Fan coil units (field supplied)
7	Fill valve (field supplied)		

Notes:

1. The example is just for application illustration; please confirm the exact installation method according to the installation manual.

5.9 Group control function for cooling, heating and DHW

Modularity is perfect when an extension of capacity becomes required as the building cooling/heating demand evolves. 6 units can be controlled in group. The group control system can control and view the operation of the entire system only by connecting the master to the wire controller. If the DHW function is required, the water tank can only be connected to the master unit water circuit through a three-way valve, and controlled by the master unit. If AHS is needed, it can only be connected to the master waterway and controlled by the master unit. The Tbt1 temperature sensor must be installed in the parallel system (otherwise unit cannot be started). If the balance tank is too large, Tbt2 needs to be added in order to improve the control accuracy. Tbt2 is set in the lower part of the balance tank. The water inlet and outlet pipe joints of each unit of the parallel system should be connected with soft connections and one-way valves must be installed at the water outlet pipe

Figure 1-5.9: Group control function for cooling, heating and DHW

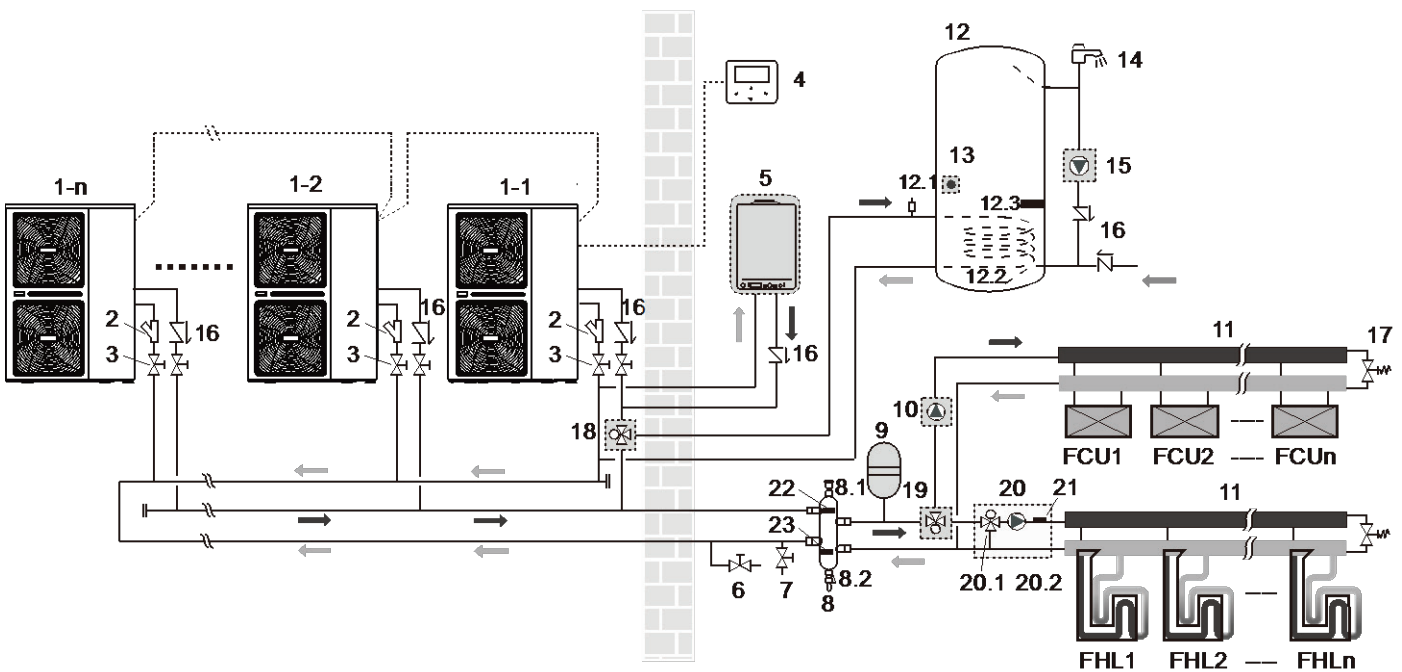

Table 1-5.9: Group control function for cooling, heating and DHW

Legend			
1-1	Outdoor unit: master	12.3	Booster heater
1-2...1-n	Outdoor unit: slave	13	T5: DHW tank temp. sensor
2	Y-shape filter	14	Hot water tap (field supply)
3	Stop valve (field supply)	15	P_d: DHW pump (field supply)
4	Wired controller	16	One way valve (field supply)
5	Additional heating source(boiler) (field supply)	17	Bypass valve(field supply)
6	Drain valve (field supply)	18	SV1: 3-way valve (field supply)
7	Fill valve (field supply)	19	SV1: 3-way valve (field supply)
8	Balance tank (field supply)	20	Mixing station (field supply)
8.1	Air purge valve	20.1	P_c: zone 2 pump (field supply)
8.2	Drain valve	20.2	SV3: 3-way valve (field supply)
9	Expansion vessel (field supply)	21	Tw2: Zone 2 water flow temp. (individual purchase)
10	P_o: Outside circulation pump (field supply)	22	Tbt1: Balance tank temp. sensor (individual purchase)
11	Collector / distributor (field supply)	23	Tbt2: Balance tank temp. sensor (individual purchase)
12	Domestic hot water tank (field supply)	FHL 1...n	Floor heating loop (field supply)
12.1	Air purge valve	FCU 1...n	Fan coil units (field supply)
12.2	Heat exchanger coil		

Notes:

1. The example is just for application illustration; please confirm the exact installation method according to the installation manual.

Part 2

Engineering Data

1 Specifications	20
2 Dimensions and Center of Gravity	21
3 Piping Diagrams	22
4 Wiring Diagrams.....	23
5 Capacity Tables.....	26
6 Operating Limits.....	32
7 Hydronic Performance.....	33
8 Sound Levels	34
9 Accessories	37

1 Specifications

Table 2-1.1: ATM18~30T specifications¹

Model name ATM			18T	22T	26T	30T	
Power supply		V/Ph/Hz	380-415/3/50				
Heating ²	Capacity	W	18000	22000	26000	30100	
	Rated input	W	3830	5000	6373	7698	
	COP			4.70	4.40	4.08	3.91
Heating ³	Capacity	W	18000	22000	26000	30000	
	Rated input	W	5143	6471	8387	10345	
	COP			3.50	3.40	3.10	2.90
Heating ⁴	Capacity	W	18000	22000	26000	30000	
	Rated input	W	6545	8302	10612	13043	
	COP			2.75	2.65	2.45	2.30
Cooling ⁵	Capacity	W	18500	23000	27000	31000	
	Rated input	W	3895	5000	6279	7750	
	EER			4.75	4.60	4.30	4.00
Cooling ⁶	Capacity	W	17000	21000	26000	29500	
	Rated input	W	5574	7119	9630	11569	
	EER			3.05	2.95	2.70	2.55
Seasonal space heating energy efficiency class ⁷		Water outlet at 35°C / 55°C	class	A+++ / A++	A+++ / A++	A+++ / A+	A++ / A+
SCOP		Water outlet at 35°C / 55°C		4.60 / 3.21	4.53 / 3.22	4.50 / 3.14	4.19 / 3.14
SEER		Water outlet at 7°C / 18°C		4.70 / 5.48	4.70 / 5.67	4.66 / 5.88	4.49 / 5.71
MOP / MCA		A	18.0 / 21.0	21.0 / 24.5	24.0 / 27.0	28.0 / 28.5	
Compressor		Type	Twin rotary DC inverter				
Outdoor fan motor		Type	Brushless DC motor				
Water side heat exchanger			Plate type				
Water pump	Max. pump head	m	12	12	12	12	
Refrigerant (R32)	Charged volume	kg	5.0				
Throttle type			Electronic expansion valve				
Sound power level ⁸		dB	71	73	75	77	
Unit dimension / Packing dimension (W×H×D)		mm	1129×1558×440 / 1220×1735×565				
Net / Gross weight		kg	177 / 206				
Water piping connections Dia.		inch	1-1/4" BSP	1-1/4" BSP	1-1/4" BSP	1-1/4" BSP	
Ambient temperature range	Cooling	°C	-5-46				
	Heating	°C	-25-35				
	DHW	°C	-25-43				
Water outlet temperature range	Cooling	°C	5-25				
	Heating	°C	25-60				
	DHW	°C	40-60				

- Notes: 1. Relevant EU standards and legislation: EN14511; EN14825; EN50564; EN12102; (EU) No 811/2013; (EU) No 813/2013; OJ 2014/C 207/02.
 2. Outdoor air temperature 7°C DB, 85% R.H.; EWT 30°C, LWT 35°C.
 3. Outdoor air temperature 7°C DB, 85% R.H.; EWT 40°C, LWT 45°C.
 4. Outdoor air temperature 7°C DB, 85% R.H.; EWT 47°C, LWT 55°C.
 5. Outdoor air temperature 35°C DB; EWT 23°C, LWT 18°C.
 6. Outdoor air temperature 35°C DB; EWT 12°C, LWT 7°C.
 7. Seasonal space heating energy efficiency class tests in average climate conditions.
 8. Test standard : EN12102-1

2 Dimensions and Center of Gravity

Figure 2-2.1: ATM18~30T dimensions and center of gravity (unit: mm)

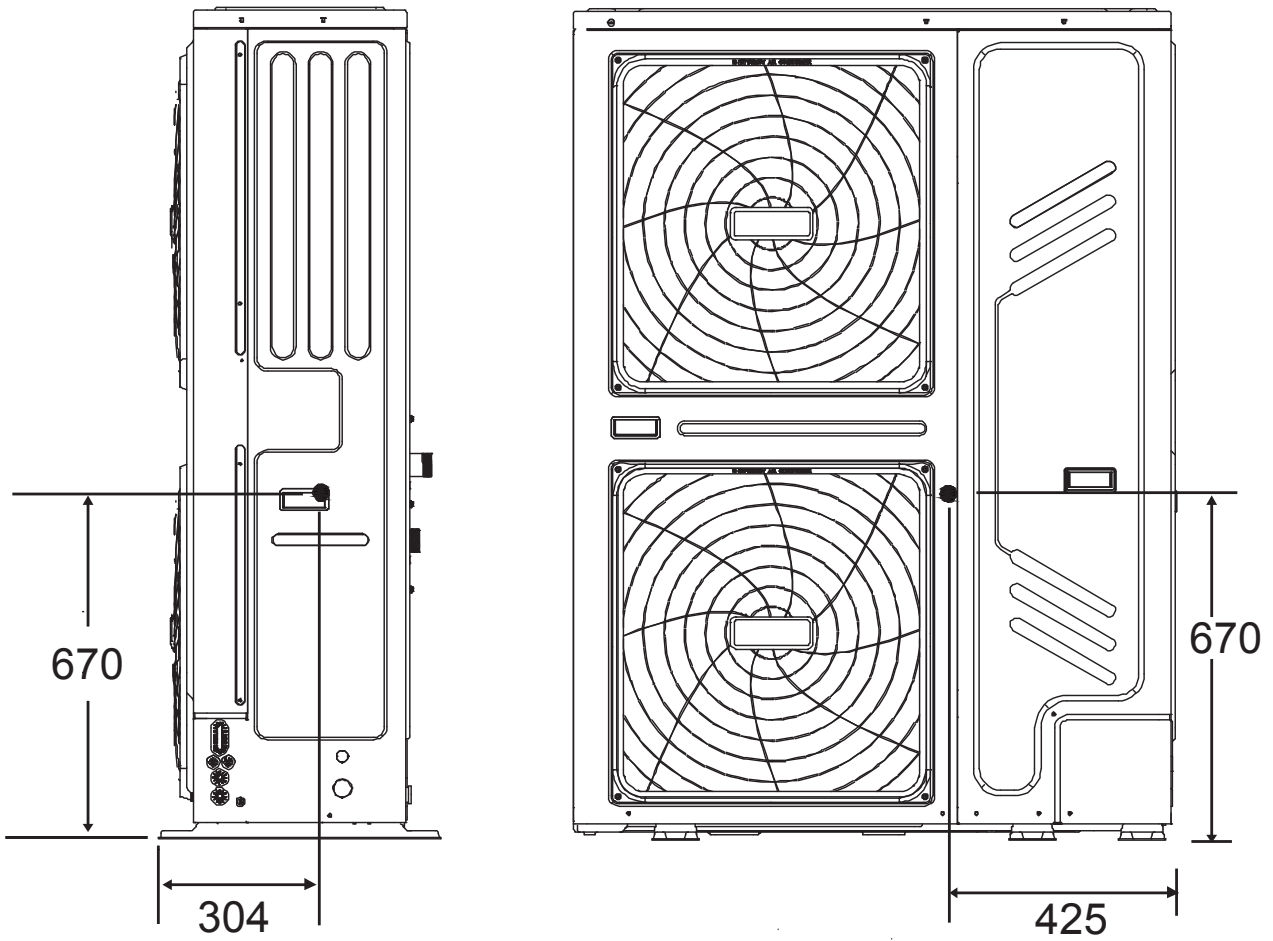

3 Piping Diagrams

Figure 2-3.1: ATM18~30T piping diagram

Number	Sensor name	Sensor code
1	Suction pipe temperature sensor	Th
2	Discharge pipe temperature sensor	Tp
3	Outdoor ambient temperature sensor	T4
4	Air side heat exchanger refrigerant outlet temperature sensor	T3
5	Water side heat exchanger refrigerant outlet (gas pipe) temperature sensor	T2B
6	Water side heat exchanger refrigerant outlet (liquid pipe) temperature sensor	T2
7	Water side heat exchanger water outlet temperature sensor	Tw_out
8	Water side heat exchanger water inlet temperature sensor	Tw_in
9	Final water outlet temperature sensor	T1
10	Domestic hot water tank temperature sensor	T5
11	Room temperature sensor (Built-in controller)	Ta

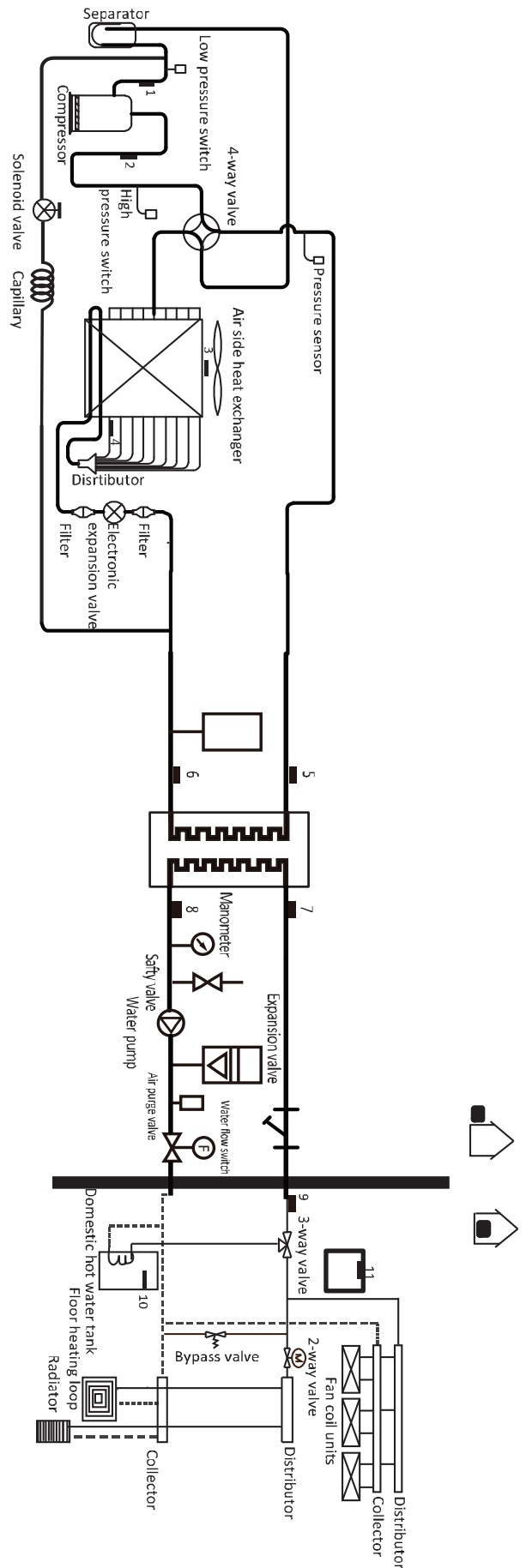

4 Wiring Diagrams

Figure 2-4.1: ATM18~30T wiring diagram

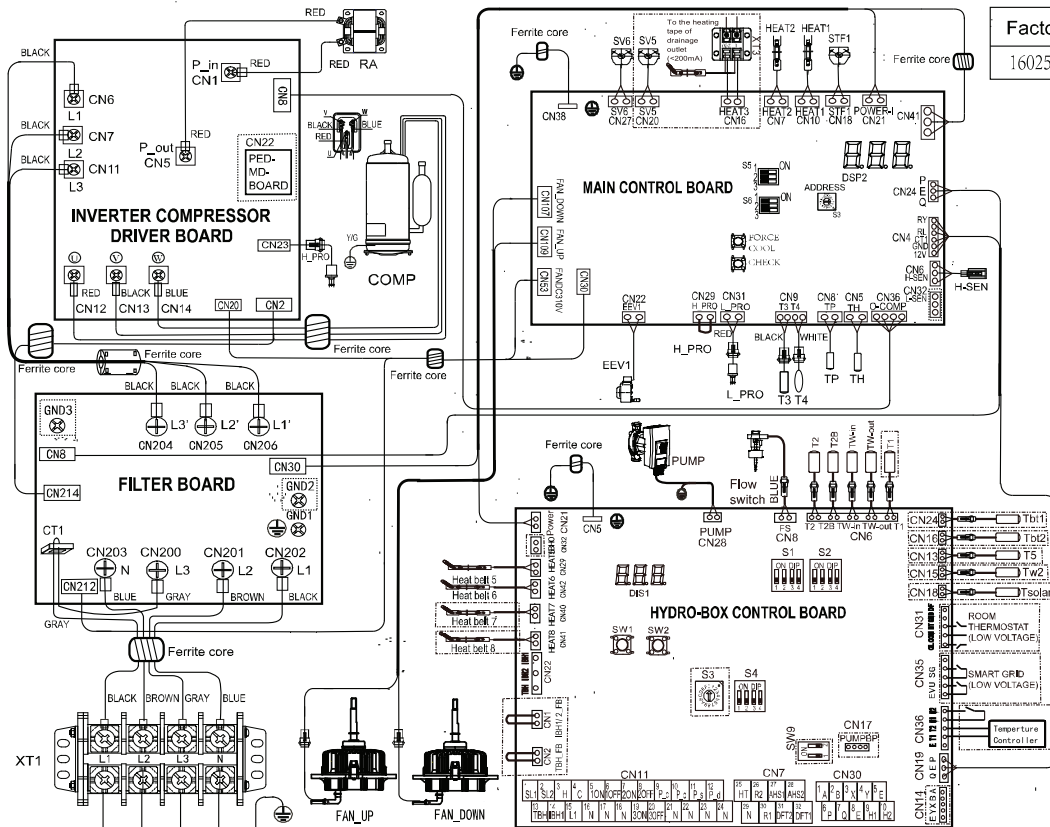

Factory code	Date	Revision
16025300005215	2020. 07. 03	K

CODE	NAME
COMP	Inverter compressor
EEV1/2	Electric expansion valve
FAN_UP/DOWN	DC fan motor
HEAT1/HEAT2	Crankcase heating
H_PRO/L_PRO	High/Low pressure switch
HX-SEN	High pressure sensor
XT1	Big 4-phase terminal
CT1	AC current transformer
RA	Reactor
STF1/STF2	4-way valve
SV5/SV6	Solenoid valve
T3/T3A	Piping temperature sensor
T4	Outdoor ambient temperature sensor
TP	Compressor exhaust temperature sensor
TH	Compressor return temperature sensor

AHS	Additional heat source
DHW	Domestic hot water
HT/CL	Heat mode/Cool mode(thermostat)
KMS/KM11	AC Contactor
SV1-3	Motorized 3-way valve (field supply)
PUMP	Internal circulator pump
P_c	Zone 2 pump(field supply)
P_d	DHW pipe pump (field supply)
P_o	Outside circulator pump (field supply) or Zone 1 pump (field supply)
P_s	Solar pump
M1/M2	Remote switch
FS	Commercial power
SG	Solar energy
EVU	Commercial power
T2, T2B, TW-in, TW-out, T1, Tbt1, Tbt2, T5, Tw2, Tisolr	Temperature sensor

Temp.sensor code	Property values
T2/T2B	$B_{25/50}=4100K, R_{25C}=10k\Omega$
T1/TW_out, TW_in/T5/T1B	$B_{30/100}=3970K, R_{25C}=17.6k\Omega$

CN35-SMART GRID		
Operating behavior	EVU	SG
Increased operation output	ON	ON
Normal operation output	OFF	ON
Decreased operation output	OFF	OFF

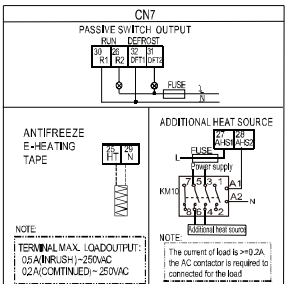

POWER SUPPLY
380-415V 3N~

- 1.Equipment must be grounded.
- 2.All high-voltage external load, if it is metal or a grounded port, must be grounded.
- 3.All external load current is needed less than 0.2A, if the single load current is greater than 0.2A, the load must be controlled through AC contactor.
- 4.AHS1~"AHS2", "A11" "A2", "R1" "R2" and "DFT1" "DFT2" wiring terminal ports provide only the switch signal.
- 5.Expansion valve E-Heating tape, Plate heat exchanger E-Heating tape and Flow switch E-Heating tape share a control port.

Leakage Protection Switch must be installed to the Power Supply of the unit.

After power off, it will take 5 minutes to power on

The wiring picture shown is for reference only, actual product may vary.

Figure 2-4.2: ATM18~30T group control system wiring diagram

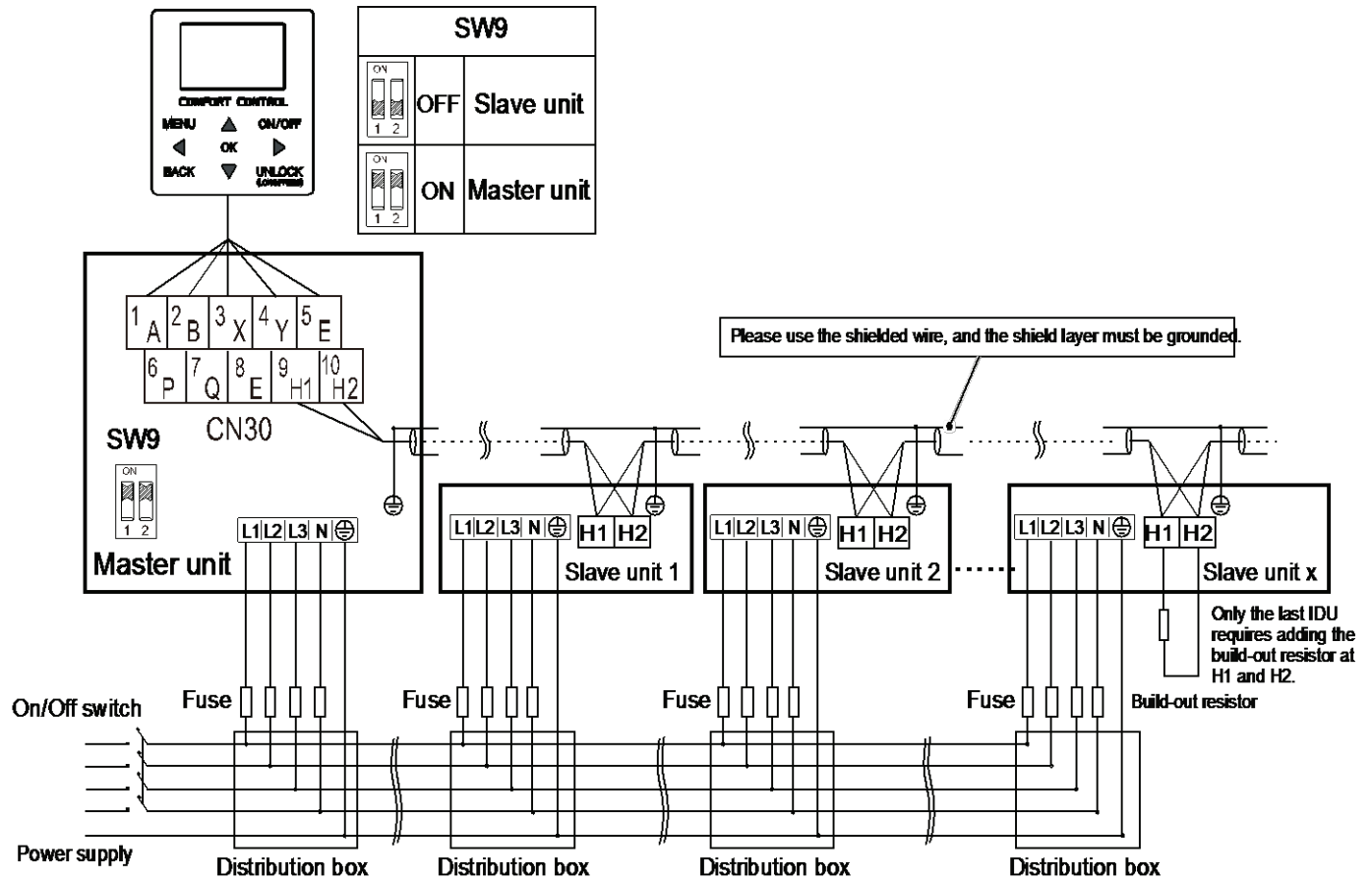

Notes:

1. Inventor recommends 6 units to be controlled by one controller and installed by reversed return water system for better hydraulic equilibrium.
2. In order to ensure the success of automatic addressing, all machines must be connected to the same power supply and powered on uniformly.
3. Only the master unit can connect the controller, and SW9 on hydronic PCB should be switched to “on” for the master unit. The slave units can not connect the controller.
4. Please use the shielded wire and the shield layer must be grounded.
5. When the communication between the unit is unstable, please add a network matching wire between the ports H1 and H2 at the terminal of the communication system
6. When connecting to the power supply terminal, use the circular wiring terminal with the insulation casing (see Figure 2-4.3).
7. Use power cord that conforms to the specifications and connect the power cord firmly. To prevent the cord from being pulled out by external force, make sure it is fixed securely.
8. If circular wiring terminal with the insulation casing cannot be used, please make sure that: Do not connect two power cords with different diameters to the same power supply terminal (may cause overheating of wires due to loose wiring) (See Figure 2-4.4).

Figure 2-4.3

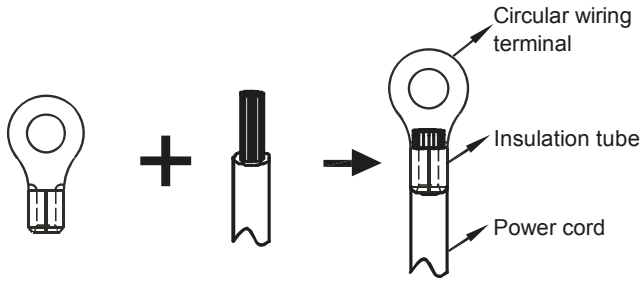
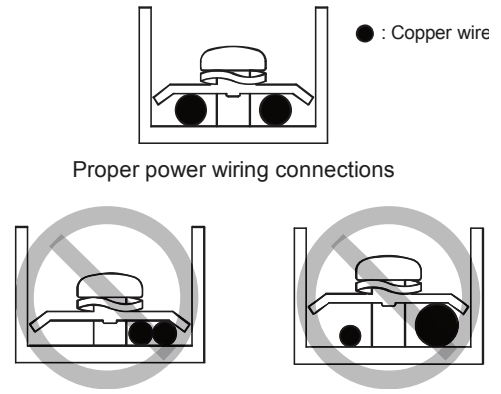
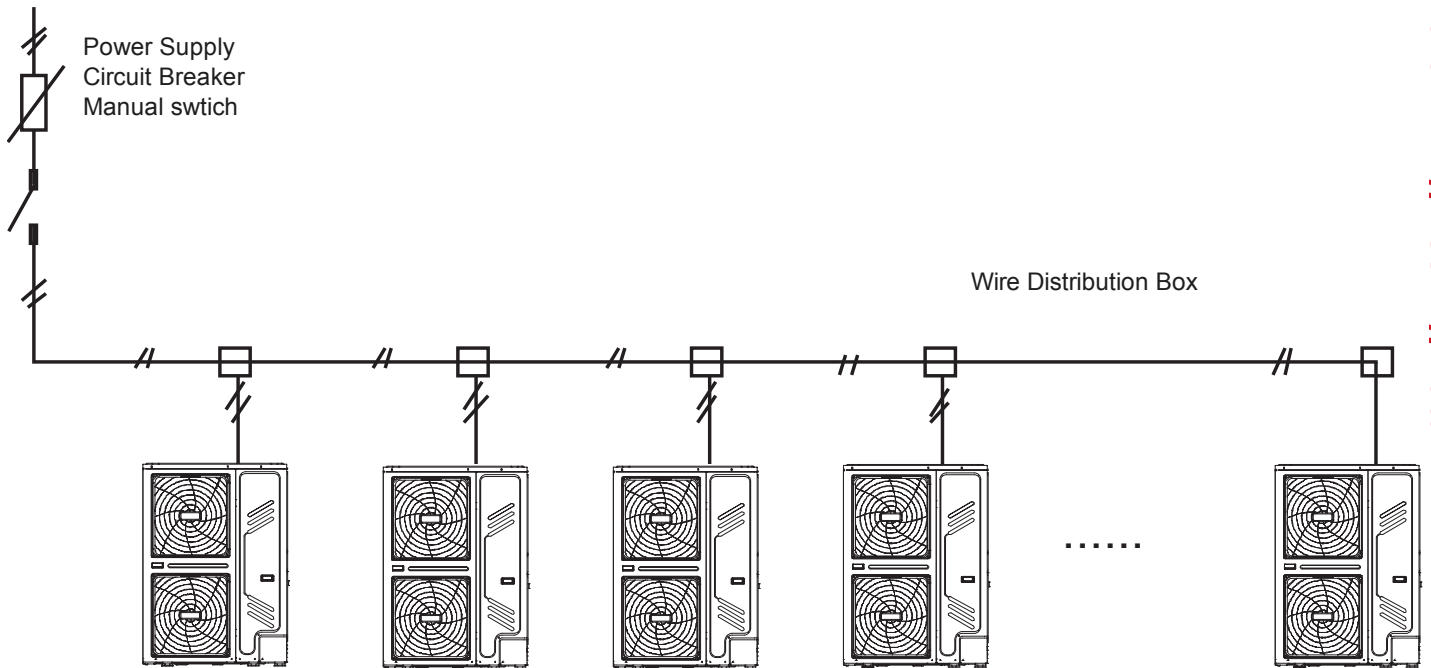

Figure 2-4.4



9. Power Cord Connection of group control system

Use a dedicated power supply for the indoor unit that is different from the power supply for the outdoor unit. Use the same power supply, circuit breaker and leakage protective device for the indoor units connected to the same outdoor unit.



5 Capacity Tables

5.1 Heating Capacity Tables (Test standard: EN14511)

Table 2-5.1: ATM18T heating capacity - peak values¹

Outdoor air temp. °C DB	LWT (°C)																					
	30			35			40			45			50			55			60			
	HC	PI	COP	HC	PI	COP	HC	PI	COP	HC	PI	COP	HC	PI	COP	HC	PI	COP	HC	PI	COP	
-25.0	10191	6401	1.59	9069	6788	1.34																
-20.0	12939	6013	2.15	11515	6376	1.81	10091	6739	1.50													
-15.0	20078	7699	2.61	19027	8151	2.33	17841	9048	1.97	15171	9112	1.66	12715	9070	1.40							
-7.0	24296	8831	2.75	23577	9241	2.55	23266	9824	2.37	20360	9253	2.20	18743	9163	2.05	10735	8784	1.22	8565	7170	1.19	
-2.0	26720	7980	3.35	25246	8346	3.02	24294	8836	2.75	23360	9301	2.51	21178	9626	2.20	13926	9310	1.50	11838	8353	1.42	
2.0	25962	6948	3.74	25494	7477	3.41	25026	8006	3.13	24558	8535	2.88	23848	9184	2.60	20623	8764	2.35	19015	9387	2.03	
7.0	21884	5019	4.36	20738	5313	3.90	19593	5608	3.49	18447	5902	3.13	18424	6805	2.71	18401	7707	2.39	18378	8610	2.13	
15.0	23370	5157	4.53	22078	5109	4.32	20786	5061	4.11	20886	5372	3.89	19338	5484	3.53	19182	5954	3.22	19026	6424	2.96	
20.0	25031	5384	4.65	23779	5329	4.46	22527	5273	4.27	21275	5217	4.08	20829	5569	3.74	20382	5921	3.44	19935	6273	3.18	
25.0	24785	5211	4.76	23660	5152	4.59	22535	5093	4.43	21410	5033	4.25	20725	5250	3.95	20040	5468	3.67	19355	5685	3.40	
30.0	26328	5423	4.85	25240	5356	4.71	24153	5289	4.57	23065	5222	4.42	22110	5330	4.15	21154	5437	3.89	20199	5545	3.64	
35.0	12774	1712	7.46	12484	1898	6.58	12195	2085	5.85	11905	2271	5.24	11516	2596	4.44	11127	2920	3.81				

Abbreviations:

LWT: Leaving water temperature (°C)

HC: Total heating capacity (W)

PI: Power input (W)

Notes:

1. Peak heating capacity values do not take account of capacity drops caused by frost accumulation and during defrosting.

Table 2-5.2: ATM18T heating capacity - integrated values¹

Outdoor air temp. °C DB	LWT (°C)																					
	30			35			40			45			50			55			60			
	HC	PI	COP	HC	PI	COP	HC	PI	COP	HC	PI	COP	HC	PI	COP	HC	PI	COP	HC	PI	COP	
-25.0	8684	6028	1.44	7841	6518	1.20																
-20.0	11025	5663	1.95	9955	6123	1.63	8885	6583	1.35													
-15.0	15468	6961	2.22	14693	6973	2.11	14167	8250	1.72	12439	8742	1.42	10822	9073	1.19							
-7.0	21075	8180	2.58	19906	8414	2.37	19071	8803	2.17	16156	8169	1.98	14349	7978	1.80	10075	8515	1.18	8038	7435	1.08	
-2.0	22479	7183	3.13	20516	7346	2.79	19021	7627	2.49	17570	7892	2.23	16322	8364	1.95	12613	8870	1.42	10722	8815	1.22	
2.0	20355	5816	3.50	20228	6397	3.16	20101	6979	2.88	19974	7560	2.64	19936	8410	2.37	17735	8254	2.15	16838	8572	1.96	
7.0	21884	5019	4.36	20738	5313	3.90	19593	5608	3.49	18447	5902	3.13	18424	6805	2.71	18401	7707	2.39	18378	8610	2.13	
15.0	23370	5157	4.53	22078	5109	4.32	20786	5061	4.11	20886	5372	3.89	19338	5484	3.53	19182	5954	3.22	19026	6424	2.96	
20.0	25031	5384	4.65	23779	5329	4.46	22527	5273	4.27	21275	5217	4.08	20829	5569	3.74	20382	5921	3.44	19935	6273	3.18	
25.0	24785	5211	4.76	23660	5152	4.59	22535	5093	4.43	21410	5033	4.25	20725	5250	3.95	20040	5468	3.67	19355	5685	3.40	
30.0	26328	5423	4.85	25240	5356	4.71	24153	5289	4.57	23065	5222	4.42	22110	5330	4.15	21154	5437	3.89	20199	5545	3.64	
35.0	12774	1712	7.46	12484	1898	6.58	12195	2085	5.85	11905	2271	5.24	11516	2596	4.44	11127	2920	3.81				

Abbreviations:

LWT: Leaving water temperature (°C)

HC: Total heating capacity (W)

PI: Power input (W)

Notes:

1. Integrated heating capacity values take account of capacity drops caused by frost accumulation and during defrosting.

Table 2-5.3: ATM22T heating capacity - peak values¹

Outdoor air temp.	LWT (°C)																					
	30			35			40			45			50			55			60			
°C DB	HC	PI	COP	HC	PI	COP	HC	PI	COP	HC	PI	COP	HC	PI	COP	HC	PI	COP	HC	PI	COP	
-25.0	9328	6216	1.50	8359	6583	1.27																
-20.0	12899	6067	2.13	11566	6424	1.80	10234	6782	1.51													
-15.0	19637	7474	2.63	19112	8206	2.33	17334	9221	1.88	15482	10266	1.51	13359	10279	1.30							
-7.0	24093	8159	2.95	23733	9254	2.56	23791	9963	2.39	23836	10691	2.23	21846	10470	2.09	13558	10441	1.30	9946	8124	1.22	
-2.0	28722	8702	3.30	27958	9343	2.99	27680	10163	2.72	27375	11005	2.49	23397	10626	2.20	18573	11196	1.66	14958	11305	1.32	
2.0	29878	7993	3.74	29100	8743	3.33	28321	9492	2.98	27542	10242	2.69	27112	10959	2.47	24629	10778	2.29	22717	11224	2.02	
7.0	25997	6215	4.18	24925	6468	3.85	23891	7096	3.37	22657	7511	3.02	22706	8542	2.66	22775	9089	2.51	22443	10552	2.13	
15.0	28916	6484	4.46	28048	6789	4.13	27180	7095	3.83	26312	7401	3.56	25450	7657	3.32	24588	7913	3.11	23726	8169	2.90	
20.0	28642	6171	4.64	27752	6407	4.33	26862	6644	4.04	25972	6881	3.77	24963	7064	3.53	23953	7248	3.30	22944	7431	3.09	
25.0	28913	6010	4.81	27988	6192	4.52	27063	6373	4.25	26138	6555	3.99	24984	6679	3.74	23830	6803	3.50	22676	6928	3.27	
30.0	30920	6224	4.97	29906	6364	4.70	28892	6505	4.44	27878	6645	4.20	26518	6722	3.95	25158	6798	3.70	23799	6875	3.46	
35.0	12748	1735	7.35	12458	1923	6.48	12167	2110	5.77	11877	2298	5.17	11536	2619	4.41	11196	2940	3.81				

Abbreviations:

LWT: Leaving water temperature (°C)

HC: Total heating capacity (W)

PI: Power input (W)

Notes:

1. Integrated heating capacity values take account of capacity drops caused by frost accumulation and during defrosting.

Table 2-5.4: ATM22T heating capacity - integrated values¹

Outdoor air temp.	LWT (°C)																					
	30			35			40			45			50			55			60			
°C DB	HC	PI	COP	HC	PI	COP	HC	PI	COP	HC	PI	COP	HC	PI	COP	HC	PI	COP	HC	PI	COP	
-25.0	7995	5857	1.37	7374	6340	1.16																
-20.0	11062	5716	1.94	10223	6188	1.65	9383	6660	1.41													
-15.0	17158	7178	2.39	15913	7348	2.17	14246	8564	1.66	12511	9818	1.27	11206	10007	1.12							
-7.0	22348	8404	2.66	21279	8704	2.44	20570	9223	2.23	19824	9754	2.03	17426	9425	1.85	12547	10034	1.25	9204	7904	1.16	
-2.0	24215	8052	3.01	23364	8471	2.76	22915	9219	2.49	22435	9988	2.25	18925	9595	1.97	15713	10074	1.56	13392	10067	1.33	
2.0	23355	6959	3.36	23244	7692	3.02	23132	8425	2.75	23021	9157	2.51	22908	9959	2.30	21042	9933	2.12	19629	10005	1.96	
7.0	25997	6215	4.18	24925	6468	3.85	23891	7096	3.37	22657	7511	3.02	22706	8542	2.66	22775	9089	2.51	22443	10552	2.13	
15.0	28916	6484	4.46	28048	6789	4.13	27180	7095	3.83	26312	7401	3.56	25450	7657	3.32	24588	7913	3.11	23726	8169	2.90	
20.0	28642	6171	4.64	27752	6407	4.33	26862	6644	4.04	25972	6881	3.77	24963	7064	3.53	23953	7248	3.30	22944	7431	3.09	
25.0	28913	6010	4.81	27988	6192	4.52	27063	6373	4.25	26138	6555	3.99	24984	6679	3.74	23830	6803	3.50	22676	6928	3.27	
30.0	30920	6224	4.97	29906	6364	4.70	28892	6505	4.44	27878	6645	4.20	26518	6722	3.95	25158	6798	3.70	23799	6875	3.46	
35.0	12748	1735	7.35	12458	1923	6.48	12167	2110	5.77	11877	2298	5.17	11536	2619	4.41	11196	2940	3.81				

Abbreviations:

LWT: Leaving water temperature (°C)

HC: Total heating capacity (W)

PI: Power input (W)

Notes:

1. Integrated heating capacity values take account of capacity drops caused by frost accumulation and during defrosting.

Table 2-5.5: ATM26T heating capacity - peak values¹

Outdoor air temp.	LWT (°C)																				
	30			35			40			45			50			55			60		
°C DB	HC	PI	COP	HC	PI	COP	HC	PI	COP	HC	PI	COP	HC	PI	COP	HC	PI	COP	HC	PI	COP
-25.0	8466	6031	1.40	7648	6378	1.20															
-20.0	12858	6120	2.10	11617	6472	1.79	10376	6824	1.52												
-15.0	19196	7250	2.65	19196	8261	2.32	16826	9394	1.79	14361	10561	1.36	13648	11345	1.20						
-7.0	23890	8383	2.85	24743	9597	2.58	24316	10102	2.41	24743	10962	2.26	24743	11645	2.12	16704	12198	1.37	12590	10175	1.24
-2.0	29211	8974	3.26	28195	9523	2.96	27665	10252	2.70	27099	11000	2.46	26142	11863	2.20	23013	12689	1.81	21303	14295	1.49
2.0	32747	8757	3.74	31640	10400	3.04	31078	10890	2.85	30476	12086	2.52	30411	12867	2.36	27207	12236	2.22	25583	12690	2.02
7.0	29927	7459	4.01	29083	8074	3.60	28240	8690	3.25	27396	9305	2.94	27120	10382	2.61	26843	11459	2.34	24306	11469	2.12
15.0	32415	7394	4.38	30789	7789	3.95	30707	8536	3.60	30624	9283	3.30	28930	9180	3.15	26556	8851	3.00	24905	8751	2.85
20.0	32835	7086	4.63	32475	7723	4.21	30468	7931	3.84	30126	8535	3.53	28453	8482	3.35	26780	8428	3.18	25107	8375	3.00
25.0	33747	6931	4.87	33140	7449	4.45	32533	7966	4.08	31926	8484	3.76	30146	8472	3.56	28366	8460	3.35	26586	8448	3.15
30.0	35360	6947	5.09	34511	7366	4.69	33662	7785	4.32	33725	8432	4.00	31839	8462	3.76	29952	8491	3.53	28066	8521	3.29
35.0	12722	1759	7.23	12431	1947	6.38	12140	2136	5.68	11849	2324	5.10	11557	2642	4.37	11264	2959	3.81			

Abbreviations:

LWT: Leaving water temperature (°C)

HC: Total heating capacity (W)

PI: Power input (W)

Notes:

1. Peak heating capacity values do not take account of capacity drops caused by frost accumulation and during defrosting.

Table 2-5.6: ATM26T heating capacity - integrated values¹

Outdoor air temp.	LWT (°C)																				
	30			35			40			45			50			55			60		
°C DB	HC	PI	COP	HC	PI	COP	HC	PI	COP	HC	PI	COP	HC	PI	COP	HC	PI	COP	HC	PI	COP
-25.0	7307	5685	1.29	6906	6162	1.12															
-20.0	11099	5769	1.92	10490	6253	1.68	9881	6737	1.47												
-15.0	18848	7395	2.55	17133	7723	2.22	14326	8879	1.61	11409	10070	1.13	11262	10758	1.05						
-7.0	23620	8628	2.74	23460	9316	2.52	22069	9642	2.29	21453	10307	2.08	20450	10803	1.89	15277	11629	1.31	11515	9701	1.19
-2.0	24677	8515	2.90	24199	8875	2.73	24145	9742	2.48	24074	10634	2.26	22101	11100	1.99	18394	10781	1.71	15966	10988	1.45
2.0	25523	7910	3.23	25438	8780	2.90	25806	9822	2.63	26170	10896	2.40	25967	11612	2.24	23098	11052	2.09	21594	11019	1.96
7.0	29927	7459	4.01	29083	8074	3.60	28240	8690	3.25	27396	9305	2.94	27120	10382	2.61	26843	11459	2.34	24306	11469	2.12
15.0	32415	7394	4.38	30789	7789	3.95	30707	8536	3.60	30624	9283	3.30	28930	9180	3.15	26556	8851	3.00	24905	8751	2.85
20.0	32835	7086	4.63	32475	7723	4.21	30468	7931	3.84	30126	8535	3.53	28453	8482	3.35	26780	8428	3.18	25107	8375	3.00
25.0	33747	6931	4.87	33140	7449	4.45	32533	7966	4.08	31926	8484	3.76	30146	8472	3.56	28366	8460	3.35	26586	8448	3.15
30.0	35360	6947	5.09	34511	7366	4.69	33662	7785	4.32	33725	8432	4.00	31839	8462	3.76	29952	8491	3.53	28066	8521	3.29
35.0	12722	1759	7.23	12431	1947	6.38	12140	2136	5.68	11849	2324	5.10	11557	2642	4.37	11264	2959	3.81			

Abbreviations:

LWT: Leaving water temperature (°C)

HC: Total heating capacity (W)

PI: Power input (W)

Notes:

1. Integrated heating capacity values take account of capacity drops caused by frost accumulation and during defrosting.

Table 2-5.7: ATM30T heating capacity - peak values¹

Outdoor air temp.	LWT (°C)																					
	30			35			40			45			50			55			60			
°C DB	HC	PI	COP	HC	PI	COP	HC	PI	COP	HC	PI	COP	HC	PI	COP	HC	PI	COP	HC	PI	COP	
-25.0	7869	6255	1.26	7181	6605	1.09																
-20.0	13266	6606	2.01	12076	6976	1.73	10887	7347	1.48													
-15.0	19411	7517	2.58	19955	8898	2.24	16890	10236	1.65	13704	11616	1.18	13400	12465	1.08							
-7.0	24516	8730	2.81	24888	9928	2.51	25711	10959	2.35	26547	12019	2.21	26933	12887	2.09	22278	14100	1.58	16470	12795	1.29	
-2.0	30739	9892	3.11	29428	10381	2.83	28618	11064	2.59	27762	11765	2.36	27612	12944	2.13	27907	14716	1.90	27664	17438	1.59	
2.0	33318	8907	3.74	31942	9481	3.37	31111	11374	2.74	30700	12748	2.41	30582	13511	2.26	29866	13781	2.17	28047	13980	2.01	
7.0	31177	8100	3.85	31754	9509	3.34	30825	9810	3.14	30992	11268	2.75	31077	12097	2.57	30563	13819	2.21	27332	12943	2.11	
15.0	31835	7396	4.30	32695	8637	3.79	34334	10108	3.40	36014	11636	3.09	34020	11332	3.00	32585	11237	2.90	27197	9762	2.79	
20.0	32636	7055	4.63	32977	8075	4.08	34150	9322	3.66	35340	10620	3.33	33608	10510	3.20	32477	10618	3.06	27137	9328	2.91	
25.0	33876	6869	4.93	33763	7710	4.38	34535	8776	3.94	35302	9885	3.57	33766	9942	3.40	32877	10226	3.22	27519	9093	3.03	
30.0	36747	7036	5.22	36198	7749	4.67	36587	8684	4.21	36947	9657	3.83	35488	9862	3.60	34721	10306	3.37	29225	9313	3.14	
35.0	12696	1782	7.12	12405	1972	6.29	12113	2161	5.61	11821	2351	5.03	11577	2665	4.34	11333	2979	3.80				

Abbreviations:

LWT: Leaving water temperature (°C)

HC: Total heating capacity (W)

PI: Power input (W)

Notes:

1. Integrated heating capacity values take account of capacity drops caused by frost accumulation and during defrosting.

Table 2-5.8: ATM30T heating capacity - integrated values¹

Outdoor air temp.	LWT (°C)																					
	30			35			40			45			50			55			60			
°C DB	HC	PI	COP	HC	PI	COP	HC	PI	COP	HC	PI	COP	HC	PI	COP	HC	PI	COP	HC	PI	COP	
-25.0	7406	6210	1.19	7093	6800	1.04																
-20.0	11249	6302	1.79	10773	6901	1.56	10288	7500	1.37													
-15.0	19103	8078	2.36	17595	8523	2.06	14915	9884	1.51	12050	11295	1.07	11845	11459	1.03							
-7.0	23940	9425	2.54	23261	9927	2.34	22977	10735	2.14	22659	11561	1.96	21508	11943	1.80	16540	13786	1.20	12228	11043	1.11	
-2.0	25011	9301	2.69	24851	9795	2.54	25138	10846	2.32	25427	11928	2.13	23246	12272	1.89	19934	12793	1.56	17952	12818	1.40	
2.0	24994	8075	3.10	26021	9085	2.86	25959	10220	2.54	28191	12317	2.29	26388	11998	2.20	24651	12493	1.97	23085	11821	1.95	
7.0	31177	8100	3.85	31754	9509	3.34	30825	9810	3.14	30992	11268	2.75	31077	12097	2.57	30563	13819	2.21	27332	12943	2.11	
15.0	31835	7396	4.30	32695	8637	3.79	34334	10108	3.40	36014	11636	3.09	34020	11332	3.00	32585	11237	2.90	27197	9762	2.79	
20.0	32636	7055	4.63	32977	8075	4.08	34150	9322	3.66	35340	10620	3.33	33608	10510	3.20	32477	10618	3.06	27137	9328	2.91	
25.0	33876	6869	4.93	33763	7710	4.38	34535	8776	3.94	35302	9885	3.57	33766	9942	3.40	32877	10226	3.22	27519	9093	3.03	
30.0	36747	7036	5.22	36198	7749	4.67	36587	8684	4.21	36947	9657	3.83	35488	9862	3.60	34721	10306	3.37	29225	9313	3.14	
35.0	12696	1782	7.12	12405	1972	6.29	12113	2161	5.61	11821	2351	5.03	11577	2665	4.34	11333	2979	3.80				

Abbreviations:

LWT: Leaving water temperature (°C)

HC: Total heating capacity (W)

PI: Power input (W)

Notes:

1. Integrated heating capacity values take account of capacity drops caused by frost accumulation and during defrosting.

5.2 Cooling Capacity Tables (Test standard : EN14511)

Table 2-5.9: ATM18T cooling capacity

Outdoor air temp. °C DB	LWT (°C)																							
	25			22			18			15			13			10			7			5		
	CC	PI	EER	CC	PI	EER	CC	PI	EER	CC	PI	EER	CC	PI	EER	CC	PI	EER	CC	PI	EER	CC	PI	EER
45	23005	5857	3.93	20981	5876	3.57	18282	5902	3.10	18000	6556	2.75	17038	6782	2.51	15520	6811	2.28	12938	6417	2.02	11216	6154	1.82
40	24236	5049	4.80	22408	5197	4.31	19972	5396	3.70	20088	6139	3.27	19344	6451	3.00	17784	6527	2.72	15016	6200	2.42	13170	5981	2.20
35	25466	4240	6.01	23836	4519	5.27	21661	4890	4.43	22176	5722	3.88	21649	6119	3.54	20048	6242	3.21	17093	5982	2.86	15123	5809	2.60
30	27199	3660	7.43	25360	3892	6.52	22907	4201	5.45	23324	4908	4.75	22675	5244	4.32	21450	5463	3.93	18808	5355	3.51	17047	5283	3.23
25	24799	2640	9.39	23043	2799	8.23	20702	3011	6.88	20525	3434	5.98	20738	3822	5.43	20836	4271	4.88	18712	4311	4.34	17296	4338	3.99
20	21499	2298	9.36	20033	2380	8.42	18080	2489	7.26	18196	2815	6.46	19360	3250	5.96	18221	3480	5.24	16337	3585	4.56	15081	3655	4.13
15	18256	1960	9.32	17061	1980	8.61	15467	2008	7.70	15858	2255	7.03	16470	2497	6.60	16373	2752	5.95	14780	2780	5.32	13717	2798	4.90
10	16075	1733	9.28	15066	1708	8.82	13722	1674	8.20	14303	1855	7.71	15052	2040	7.38	15171	2209	6.87						
5	14841	1446	10.26	13820	1436	9.62	12458	1423	8.76	11436	1413	8.10	13060	1707	7.65	13211	1894	6.97						
0	21194	1868	11.34	19619	1871	10.49	17519	1874	9.35	15944	1876	8.50	14894	1878	7.93	13319	1880	7.08						
-5	18573	3347	5.55	17370	3155	5.51	15767	2899	5.44	14565	2707	5.38	13763	2579	5.34	12561	2387	5.26						

Abbreviations:

LWT: Leaving water temperature (°C)

CC: Total cooling capacity (W)

PI: Power input (W)

Table 2-5.10: ATM22T cooling capacity

Outdoor air temp. °C DB	LWT (°C)																							
	25			22			18			15			13			10			7			5		
	CC	PI	EER	CC	PI	EER	CC	PI	EER	CC	PI	EER	CC	PI	EER	CC	PI	EER	CC	PI	EER	CC	PI	EER
45	24059	5909	4.07	21857	5984	3.65	18920	6083	3.11	20753	7644	2.72	19982	8133	2.46	18394	8281	2.22	15755	8000	1.97	13996	7813	1.79
40	25547	5289	4.83	23508	5498	4.28	20790	5775	3.60	23278	7428	3.13	22791	8022	2.84	21085	8083	2.61	18179	7722	2.35	16242	7481	2.17
35	31695	5475	5.79	29498	5876	5.02	26568	6410	4.14	25804	7212	3.58	25600	7911	3.24	23775	7886	3.01	20873	7120	2.93	18938	6609	2.87
30	32805	4833	6.79	30457	5113	5.96	27325	5487	4.98	26491	6117	4.33	26249	6675	3.93	24797	6818	3.64	21925	6599	3.32	20011	6453	3.10
25	29567	3694	8.01	27392	3839	7.14	24491	4032	6.07	24706	4625	5.34	23846	4885	4.88	23026	5184	4.44	20716	5179	4.00	19176	5175	3.71
20	26423	3223	8.20	25189	3389	7.43	23542	3609	6.52	21581	3677	5.87	21775	3998	5.45	21025	4352	4.83	18773	4429	4.24	17272	4481	3.85
15	21288	2537	8.39	21105	2718	7.76	20861	2960	7.05	19239	2957	6.51	19671	3200	6.15	19292	3442	5.60	17399	3437	5.06	16138	3434	4.70
10	18223	2153	8.46	17097	2102	8.13	15597	2034	7.67	16079	2204	7.30	16770	2383	7.04	16794	2531	6.63						
5	14462	1734	8.34	13538	1686	8.03	12306	1622	7.59	13820	1911	7.23	14610	2093	6.98	14762	2241	6.59						
0	22126	2691	8.22	20667	2606	7.93	18721	2493	7.51	17261	2408	7.17	16288	2352	6.93	14829	2267	6.54						
-5	18833	3765	5.00	17543	3550	4.94	15824	3264	4.85	14535	3049	4.77	13675	2906	4.71	12386	2691	4.60						

Abbreviations:

LWT: Leaving water temperature (°C)

CC: Total cooling capacity (W)

PI: Power input (W)

Table 2-5.11: ATM26T cooling capacity

Outdoor air temp.	LWT (°C)																							
	25			22			18			15			13			10			7			5		
	°C DB	CC	PI	EER	CC	PI	EER	CC	PI	EER	CC	PI	EER	CC	PI	EER	CC	PI	EER	CC	PI	EER	CC	PI
45	24292	5752	4.22	21983	5881	3.74	18905	6053	3.12	20603	7674	2.68	18692	7781	2.40	18066	8335	2.17	15882	8240	1.93	14426	8177	1.76
40	25992	5350	4.86	23808	5612	4.24	20896	5962	3.51	27746	9229	3.01	25587	9488	2.70	24434	9762	2.50	21497	9373	2.29	19538	9114	2.14
35	35332	6312	5.60	32705	6817	4.80	29201	7490	3.90	32319	9723	3.32	31530	10583	2.98	29357	10325	2.84	25843	9616	2.69	23500	9144	2.57
30	40671	6489	6.27	37606	6836	5.50	33520	7300	4.59	33500	8412	3.98	32673	9061	3.61	30755	9069	3.39	27417	8684	3.16	25192	8426	2.99
25	40988	5845	7.01	37863	5988	6.32	33697	6177	5.46	32181	6652	4.84	31488	7089	4.44	30023	7356	4.08	27059	7285	3.71	25083	7238	3.47
20	32833	4532	7.24	30492	4567	6.68	27372	4614	5.93	26646	4949	5.38	26499	5275	5.02	25220	5619	4.49	22426	5661	3.96	20564	5688	3.62
15	27030	3603	7.50	25242	3565	7.08	22858	3513	6.51	22690	3742	6.06	23700	4113	5.76	22264	4198	5.30	20063	4151	4.83	18596	4119	4.51
10	24482	3143	7.79	22993	3045	7.55	21008	2914	7.21	21146	3051	6.93	21614	3209	6.74	22006	3426	6.42						
5	18107	2600	6.96	17044	2489	6.85	15626	2342	6.67	16181	2479	6.53	16932	2637	6.42	17054	2729	6.25						
0	23803	3790	6.28	22456	3593	6.25	20661	3331	6.20	19315	3134	6.16	18417	3003	6.13	17071	2806	6.08						
-5	27668	2661	10.40	25774	2590	9.95	23248	2496	9.31	21354	2425	8.80	20091	2378	8.45	18197	2307	7.89						

Abbreviations:

LWT: Leaving water temperature (°C)

CC: Total cooling capacity (W)

PI: Power input (W)

Table 2-5.11: ATM30T cooling capacity

Outdoor air temp.	LWT (°C)																							
	25			22			18			15			13			10			7			5		
	°C DB	CC	PI	EER	CC	PI	EER	CC	PI	EER	CC	PI	EER	CC	PI	EER	CC	PI	EER	CC	PI	EER	CC	PI
45	24524	5595	4.38	22109	5778	3.83	18890	6023	3.14	20452	7705	2.65	18454	7857	2.35	18197	8596	2.12	16403	8680	1.89	15206	8736	1.74
40	26438	5410	4.89	24108	5726	4.21	21002	6148	3.42	27686	9586	2.89	25383	9898	2.56	24621	10227	2.41	22087	9866	2.24	20399	9625	2.12
35	34379	6180	5.56	33308	7240	4.60	31881	8653	3.68	35981	11591	3.10	33401	12107	2.76	30194	11214	2.69	29736	12705	2.34	29431	13699	2.15
30	41579	7118	5.84	38295	7474	5.12	33917	7949	4.27	38293	10380	3.69	35557	10677	3.33	35512	11169	3.18	31911	10593	3.01	29511	10210	2.89
25	44052	7030	6.27	40581	7121	5.70	35954	7244	4.96	36544	8253	4.43	35450	8692	4.08	33685	8912	3.78	30412	8762	3.47	28230	8662	3.26
20	38765	5925	6.54	35944	5916	6.08	32183	5904	5.45	30993	6223	4.98	30535	6544	4.67	30825	7350	4.19	25479	6850	3.72	21915	6516	3.36
15	32622	4756	6.86	30453	4670	6.52	27561	4554	6.05	26212	4612	5.68	26264	4837	5.43	25291	5020	5.04	22772	4920	4.63	21093	4853	4.35
10	28779	3984	7.22	27055	3834	7.06	24757	3635	6.81	25502	3859	6.61	25011	3869	6.46	24481	3929	6.23						
5	19577	3160	6.20	18535	3123	5.94	17145	2887	5.94	17712	2981	5.94	18488	3110	5.94	18674	3139	5.95						
0	24178	4426	5.46	23068	4559	5.06	21587	4131	5.23	20477	3809	5.38	19737	3595	5.49	18627	3273	5.69						
-5	28578	4067	7.03	26544	3815	6.96	23832	3478	6.85	21798	3225	6.76	20442	3057	6.69	18408	2804	6.56						

Abbreviations:

LWT: Leaving water temperature (°C)

CC: Total cooling capacity (W)

PI: Power input (W)

6 Operating Limits

Figure 2-6.1: Heating operating limits

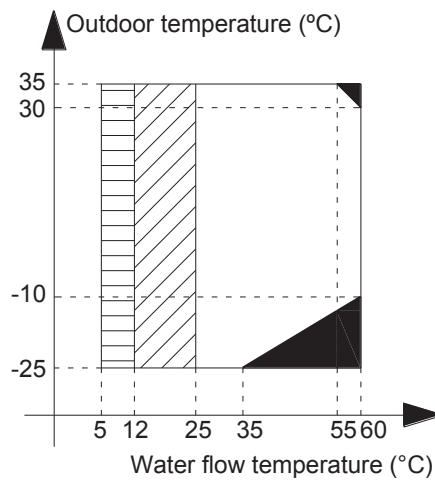

Figure 2-6.2: Cooling operating limits

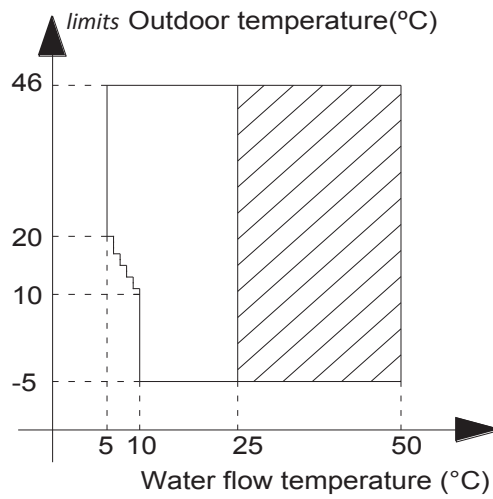
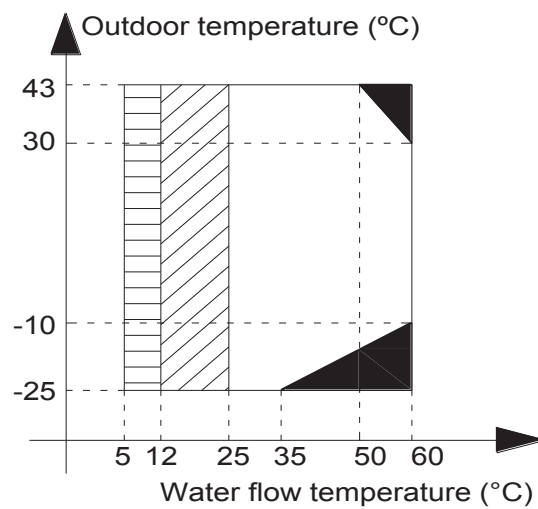

Figure 2-6.3: Domestic hot water operating limits



Notes:

- Shaded areas indicate If IBH/AHS setting is valid, only IBH/AHS turns on. If IBH/AHS setting is invalid, only heat pump turns on.
- ▨ Shaded areas indicate water flow temperature drop or rise interval
- ▤ Shaded areas indicates heat pump runs If the IBH or AHS setting is valid; no heat pump operation if IBH or AHS setting is invalid

7 Hydronic Performance

Figure 2-7.1: ATM18~30T hydronic performance¹

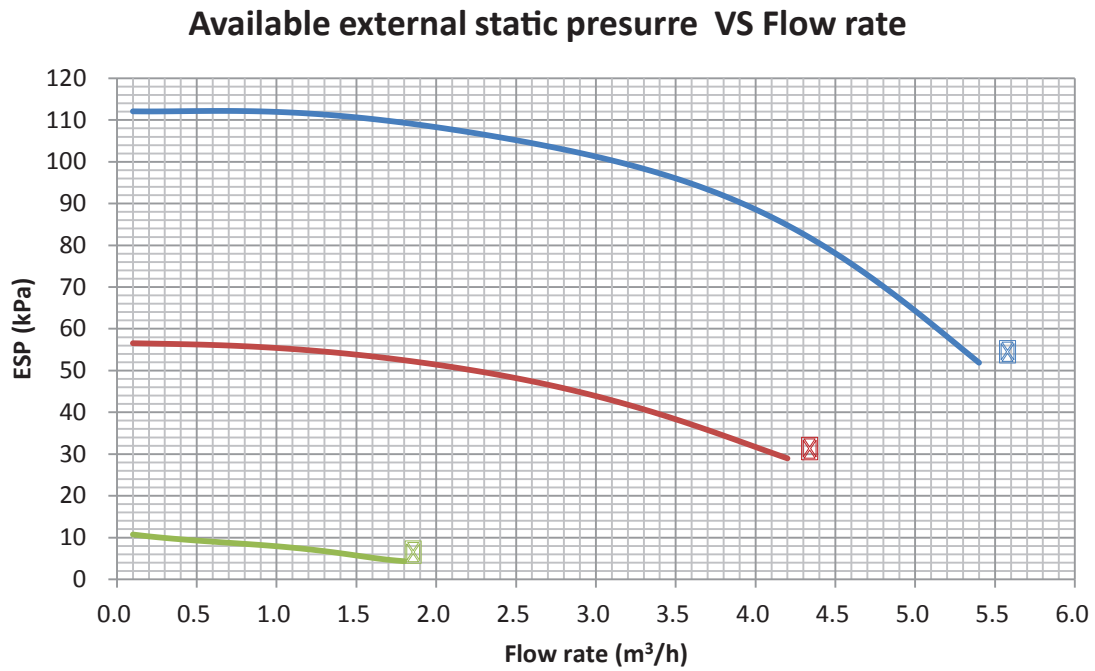

Abbreviations:

ESP: External static pressure

Notes:

- I, II and III indicate water pump speed:
 I: Low
 II: Medium
 III: High.

8 Sound Levels

8.1 Overall

Table 2-8.1: Sound pressure levels¹

Model name	dB(A) ²
ATM18T	57.6
ATM22T	59.8
ATM26T	61.5
ATM30T	63.5

Notes:

1. Sound pressure level is measured at a position 1m in front of the unit and $(1+H)/2$ m (where H is the height of the unit) above the floor in a semi-anechoic chamber. During in-situ operation, sound pressure levels may be higher as a result of ambient noise.

Figure 2-8.1: Sound pressure level measurement (unit: mm)

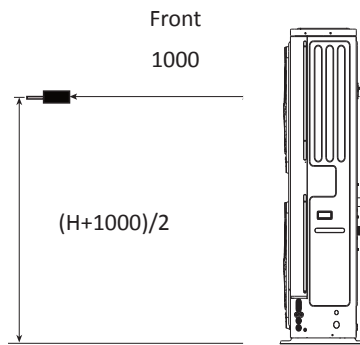

2. dB(A) is the maximum value tested under the conditions below:
 Outdoor air temperature 7°C DB, 85% R.H.; EWT 30°C, LWT 35°C.
 Outdoor air temperature 7°C DB, 85% R.H.; EWT 47°C, LWT 55°C.

8.2 Octave Band Levels

Figure 2-8.2: ATM18T octave band levels

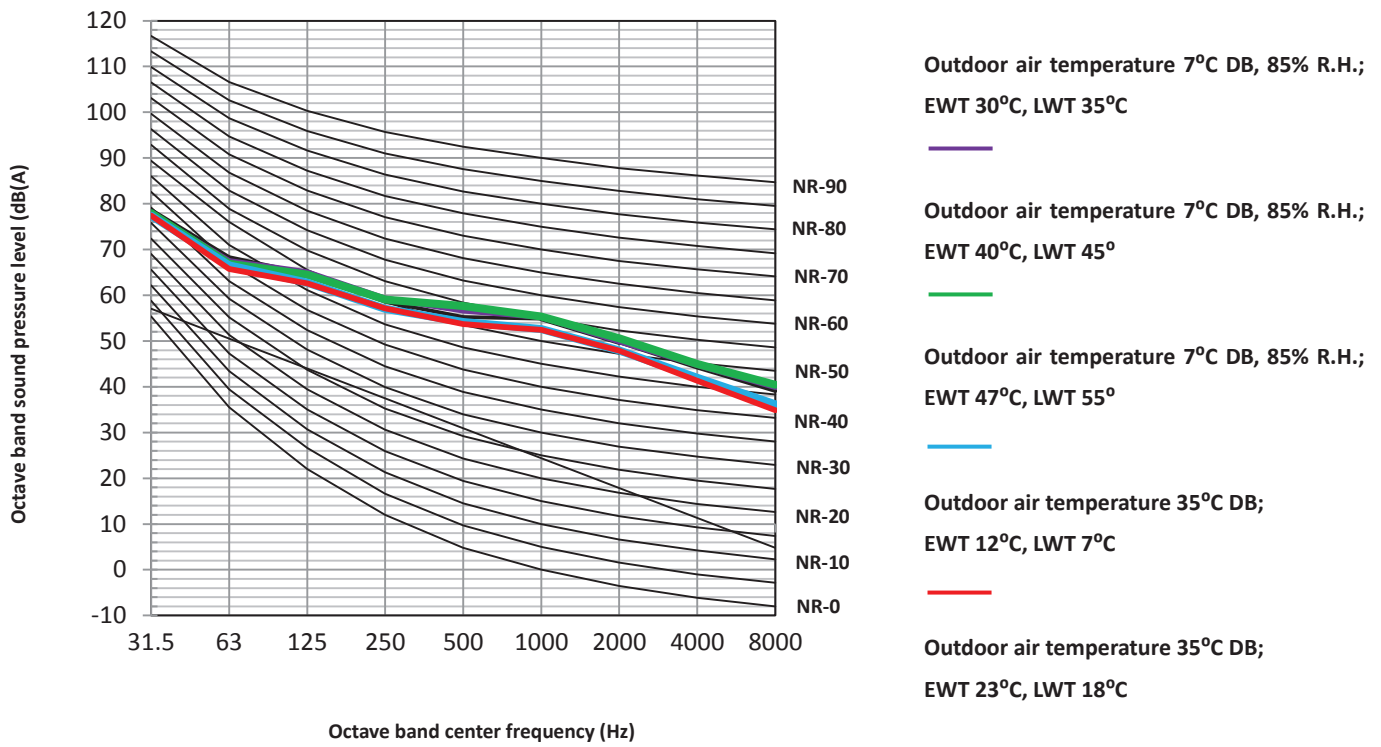

Figure 2-8.3: ATM22T octave band levels

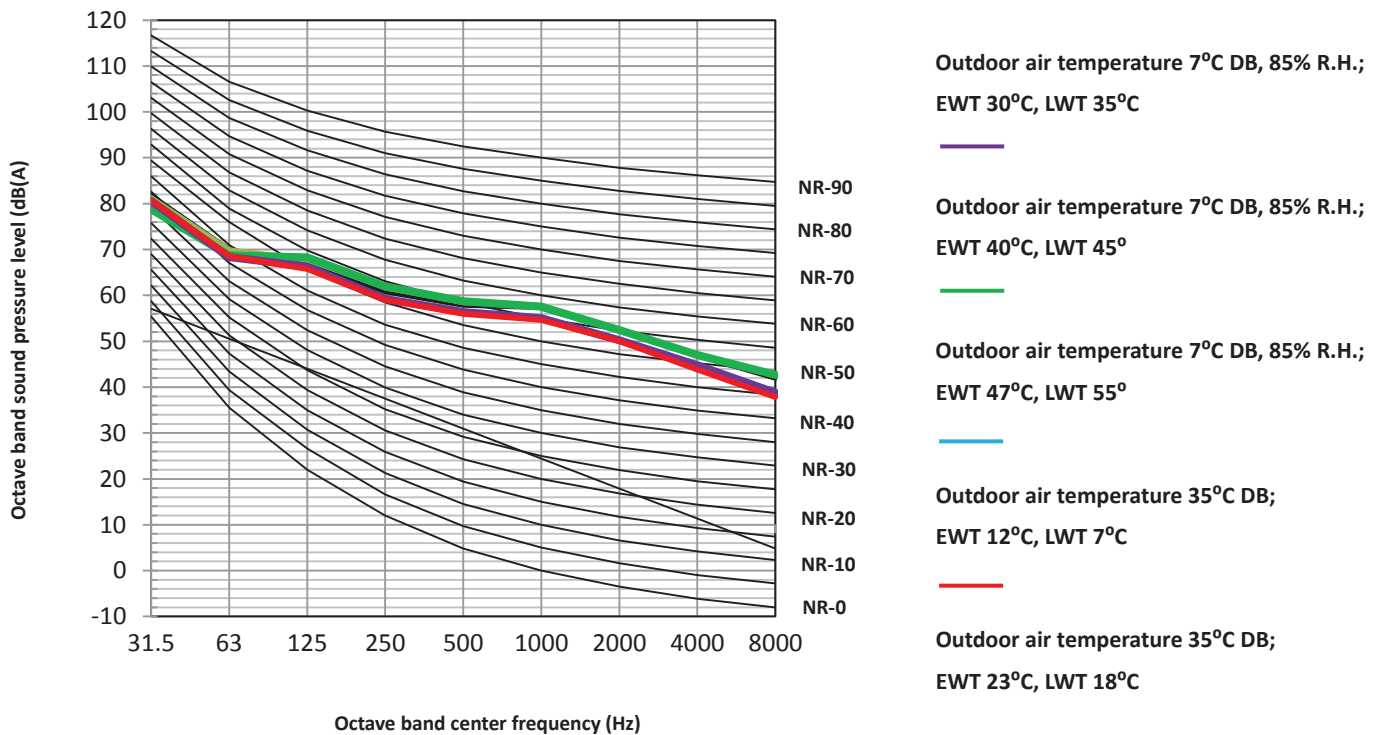

Figure 2-8.4: ATM26T octave band levels

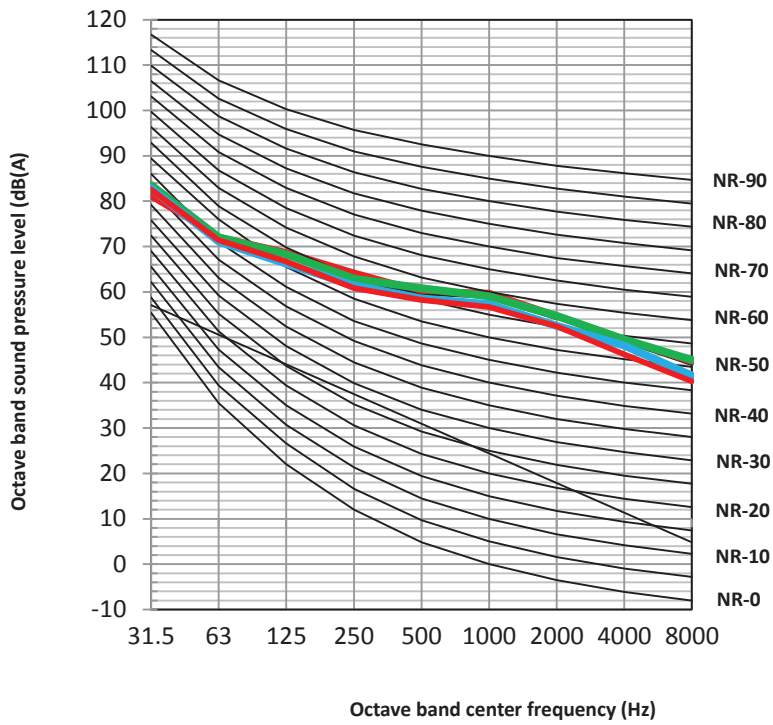
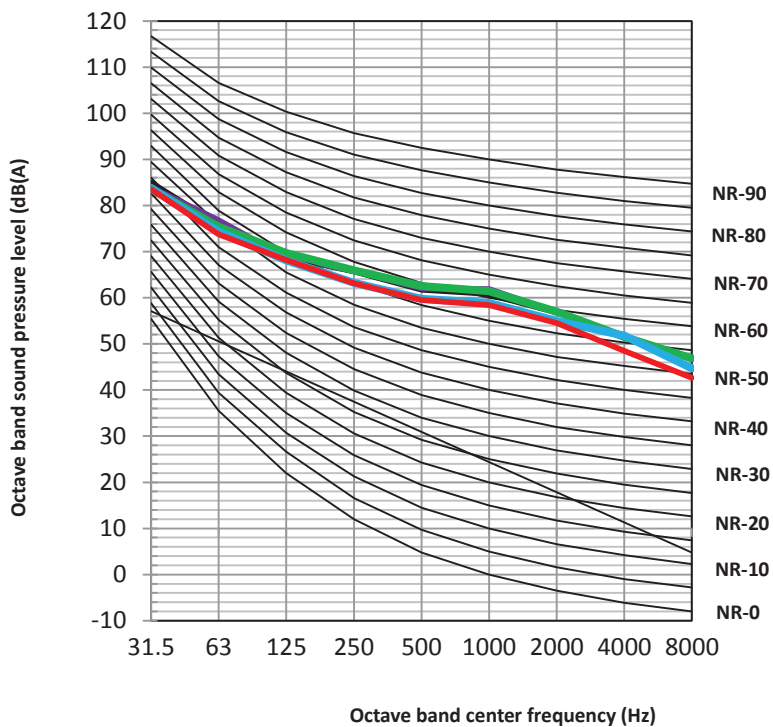













Figure 2-8.5: ATM30T octave band levels



9 Accessories









9.1 Standard accessories

Table 2-9.1: Standard accessories

Name	Shape	Quantity	Name	Shape	Quantity
Installation and owner's manual		1	Tighten belt for customer wiring use		2
Operation manual		1	Thermistor for domestic hot water tank(T5)		1
Technical data manual		1	Extension wire for T5		1
Y-shaped filter		1	Network matching wire ²		1
Water outlet connection pipe assembly		2	Adapter for inlet water pipe		1
Wired controller		1			

9.2 Optional Accessories

Table 2-9.2: Standard accessories

Name	Shape	Quantity	Name	Shape	Quantity
Thermistor for balance tank(Tbt1)		1	Extension wire for Tbt1		1
Thermistor for balance tank(Tbt2)		1	Extension wire for Tbt2		1
Thermistor for Zone 2 flow temp. (Tw2)		1	Extension wire for Tw2		1
Thermistor for solar temp. (Tsolar)		1	Extension wire for Tsolar		1

Part 3

Installation and Field Settings

1	Preface to Part 3	40
2	Installation	41
3	Water Pipework.....	46
4	Electrical Wiring.....	50
5	DIP Switch Settings	52
6	Internal Circulation Pump Speed Settings	53
7	User Interface Field Settings	55
8	Operation parameter	74
9	Network Configuration Guidelines	75
10	USB function guidelines	79
11	Appendix	81
12	Error Code Table	84

1 Preface to Part 3

1.1 Notes for Installers Boxes

The information contained in this Engineering Data Book may primarily be of use during the system design stage of a Inventor Matrix Mono project. Additional important information which may primarily be of use during field installation has been placed in boxes, such as the example below, titled “Notes for installers”.

Notes for installers



- Notes for installers boxes contain important information which may primarily be of use during field installation, rather than during desk-based system design.

1.2 Definitions

In this Engineering Data Book, the term “applicable legislation” refers to all national, local and other laws, standards, codes, rules, regulations and other legislation that apply in a given situation.

1.3 Precautions

All system installation including installation of water piping and electrical works must only be carried out by competent and suitably qualified, certified and accredited professionals and in accordance with all applicable legislation.

2 Installation

2.1 Acceptance and Unpacking

Notes for installers



- When units are delivered check whether any damage occurred during shipment. If there is damage to the surface or outside of a unit, submit a written report to the shipping company.
- Check that the model, specifications and quantity of the units delivered are as ordered.
- Check that all accessories ordered have been included. Retain the Owner's Manual for future reference.

2.2 Hoisting

Notes for installers



- Do not remove any packaging before hoisting. If units are not packaged or if the packaging is damaged, use suitable boards or packing material to protect the units.
- Hoist one unit at a time, using two ropes to ensure stability.

Figure 3-2.1: Hoisting the unit

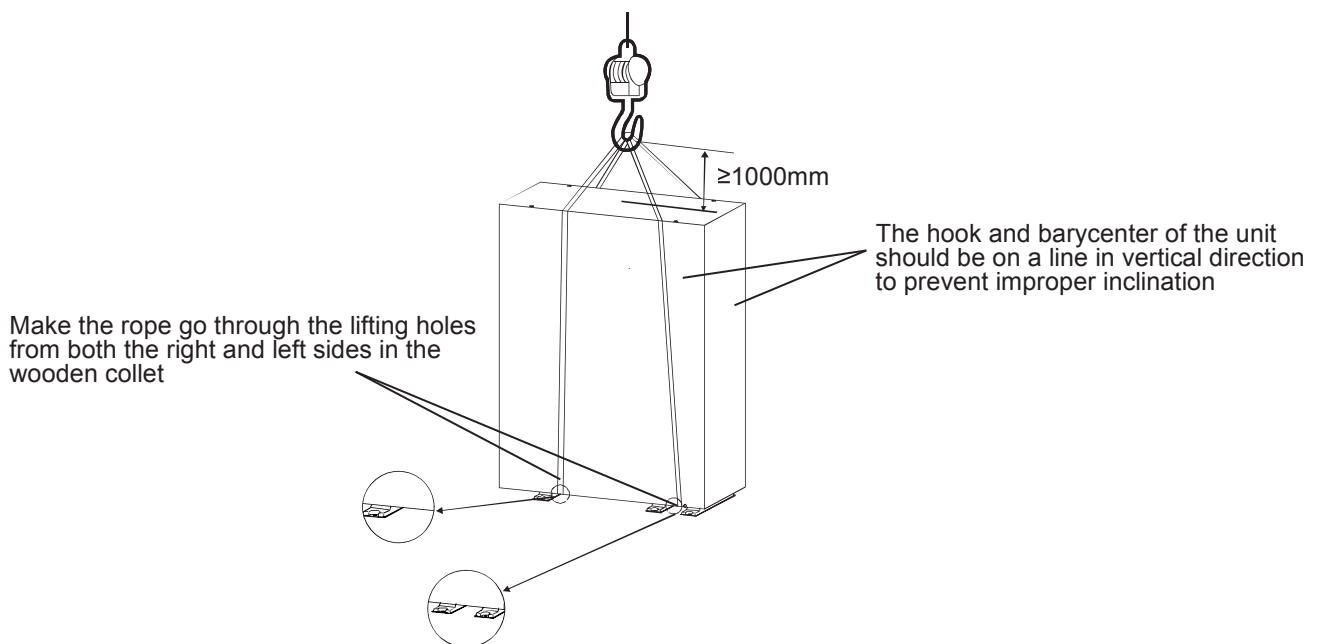

2.3 Placement Considerations

Placement of the outdoor unit should take account of the following considerations:

- Outdoor units should not be exposed to direct radiation from a high-temperature heat source or a potentially explosive atmosphere. Outdoor units should be installed in positions that are as far as possible to the heat emitters.
- Outdoor units should not be installed in positions often used as a work space. In case of construction work (e.g. grinding etc.) where dust or dirt is created and it may affect heat exchangers.
- Outdoor units should not be installed in locations where exposure to oil or to corrosive or harmful gases, such as acidic or alkaline gases, may occur.
- Outdoor units should be installed in well-drained, well-ventilated positions.
- Outdoor units should be installed in positions that are sufficiently close to the desired position of the wired controller

that the controller's wiring length limitation will not be exceeded.

- In systems that are configured to heat domestic hot water and/or include an external backup electric heater, outdoor units should be installed in positions that are sufficiently close to the domestic hot water tank and/or backup electric heater that the piping and temperature sensor wiring length come within the allowable ranges.
- Outdoor units should be installed in locations where the noise from the unit will not disturb neighbors.
- Outdoor units should be installed in safe places which can bear the unit's weight and vibration and where the unit can be installed at an even level.
- Outdoor units should be installed in positions that there is no possibility of flammable gas or product leak.
- Outdoor units should be installed in positions where servicing space can be well ensured.
- Outdoor units should be installed in positions where rain can be avoided as much as possible.

Outdoor units should be installed in clean area in case of small animals making contact with electrical parts, which can cause malfunction, smoke or fire.

There is flammable refrigerant in the unit and it should be installed in a well-ventilated site. If the unit is installed inside, an additional refrigerant detection device and ventilation equipment must be added in accordance with the standard EN378.

Adequate measures should be adopted to prevent the unit from being used as a shelter by small animals.

2.4 Strong Wind Installation

Wind of 5m/s or more blowing against an outdoor unit's air outlet blocks the flow of air through the unit, leading to deterioration in unit capacity, accelerated frost accumulation when in heating mode or domestic hot water mode, and potential disruption to operation due to increased pressure in the refrigerant circuit. Exposure to very strong wind can also cause the fan to rotate excessively fast, potentially leading to damage to the fan. In locations where exposure to high winds may occur should take account of the following considerations:

- Set the outlet side at a right angle to the direction of the wind, refer to Figure 3-2.2. For installation of the outdoor unit in a place where the wind direction can be foreseen, refer to Figure 3-2.3 for installation of the unit.
- If turn the air outlet side toward the building's wall, fence or screen. Make sure there is enough room to do the installation

Figure 3-2.2: Strong wind installation direction

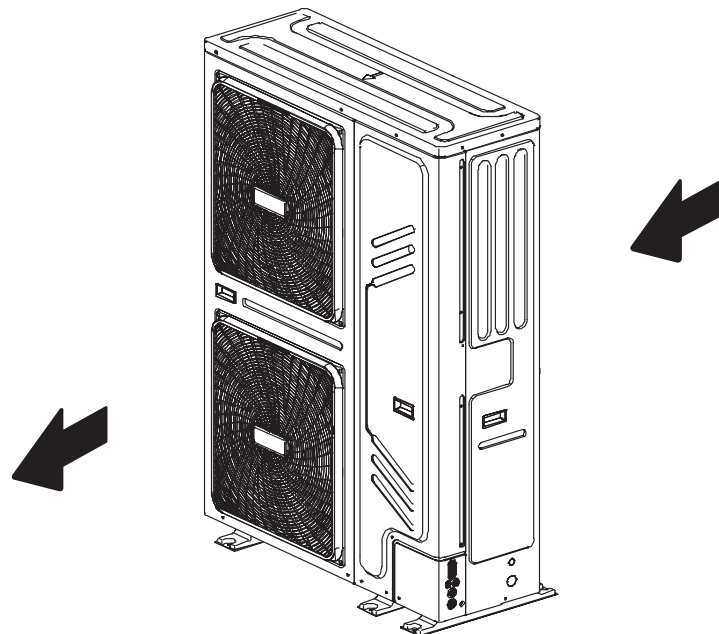
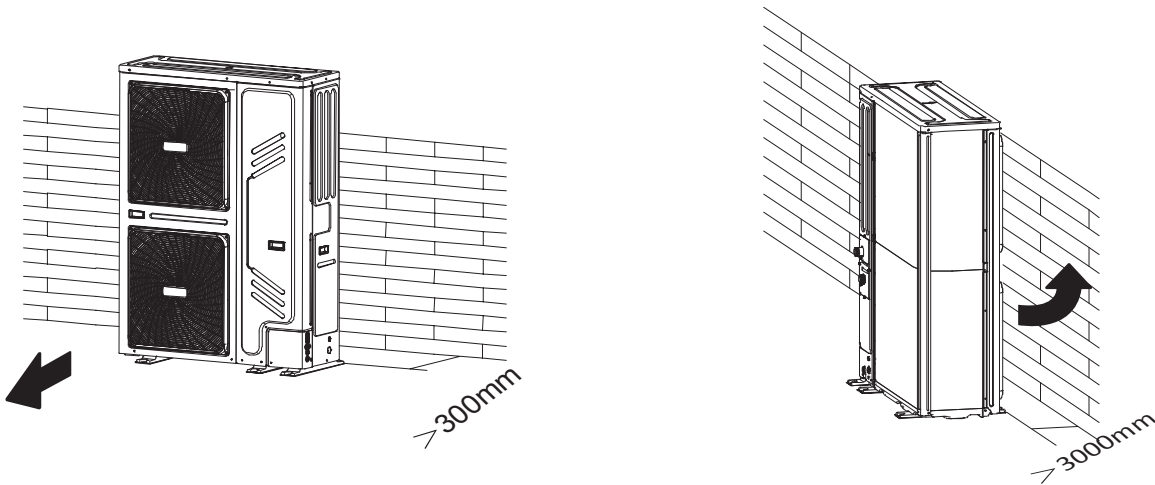

Figure 3-2.3: Installation room illustration



2.5 Cold Climate Installation

In cold climate locations installation should take account of the following considerations:

- Never install the unit at a site where the suction side may be exposed directly to wind.
- To prevent exposure to wind, install a baffle plate on the air discharge side of the unit.
- To prevent exposure to wind, install the unit with its suction side facing the wall.
- In areas of heavy snowfall, a canopy should be installed to prevent snow entering the unit. Additionally, the height of the base structure should be increased so as to raise the unit further off the ground and make sure that the heat exchanger coil is not affected by the snow. Refer to Figure 3-2.4.

Notes:

- Construct a large canopy.
- Construct a pedestal
- Install the unit high enough off the ground to prevent it from being buried in snow

Figure 3-2.4: Snow shielding

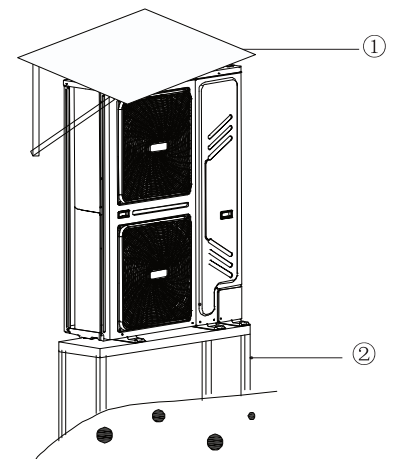

2.6 Hot Climate Installation

As the outdoor temperature is measured via the outdoor ambient temperature sensor, make sure to install the outdoor unit in the shade, or a canopy should be constructed to avoid direct sunlight. So that it is not influenced by the sun's heat, otherwise system protection may occur.

2.7 Base Structure

Outdoor unit base structure design should take account of the following considerations:

- A solid base prevents excess vibration and noise. Outdoor unit bases should be constructed on solid ground or on structures of sufficient strength to support the unit's weight.
- Bases should be at least 100mm high to provide sufficient drainage and to prevent water ingress into the base of the unit.
- Either steel or concrete bases may be suitable.
- Outdoor units should not be installed on supporting structures that could be damaged by water build-in in the event of a blocked drain.
- Fix the unit securely to foundation by means of the $\Phi 10$ expansion bolt. It is best to screw in the foundation bolts until their length is 20 mm from the foundation surface.

Figure 3-2.5: Outdoor unit typical concrete base structure design (unit: mm)

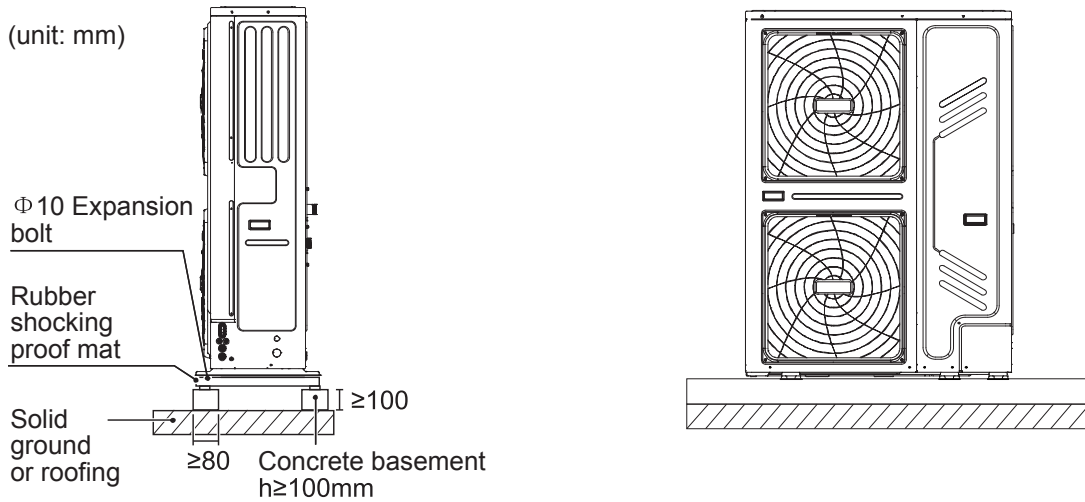

2.8 Drainage

Drainage ditch should be provided to allow drainage of condensate that may form on the air side heat exchanger when the unit is running in heating mode or domestic hot water mode. The drainage should ensure that condensate is directed away from roadways and footpaths, especially in locations where the climate is such that condensate may freeze.

Figure 3-2.6: Drainage hole

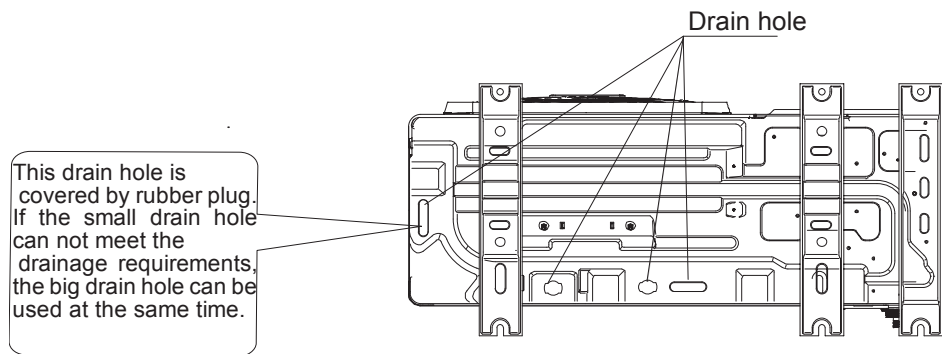

2.9 Spacing

Outdoor units must be spaced such that sufficient air may flow through each unit. Sufficient airflow across heat exchangers is essential for outdoor units to function properly. For more details please refer to the figures below.

Figure 3-2.7: Single unit installation

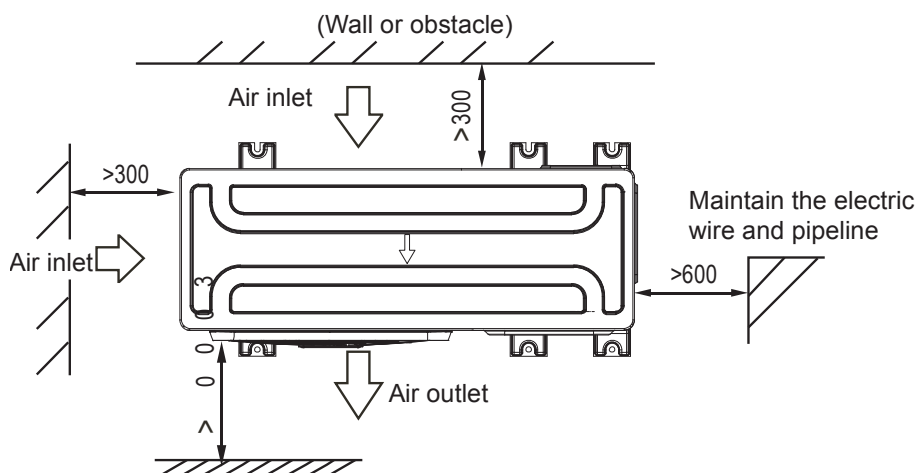

Figure 3-2.8: Parallel connect the two units or above

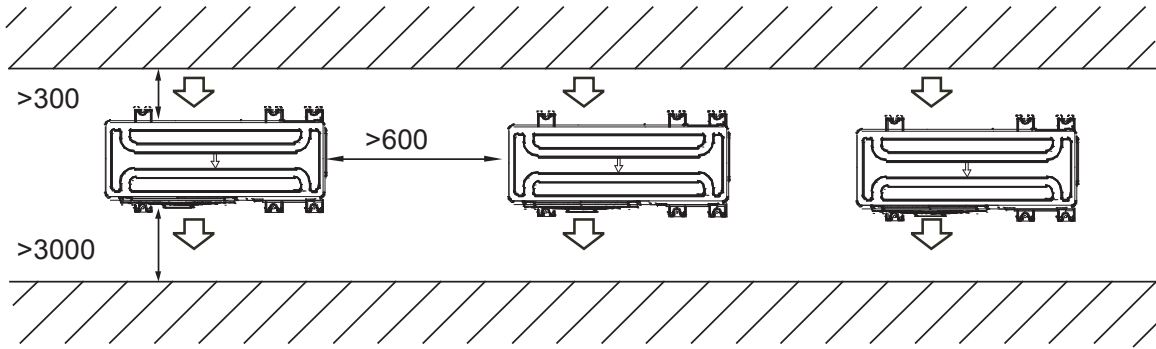
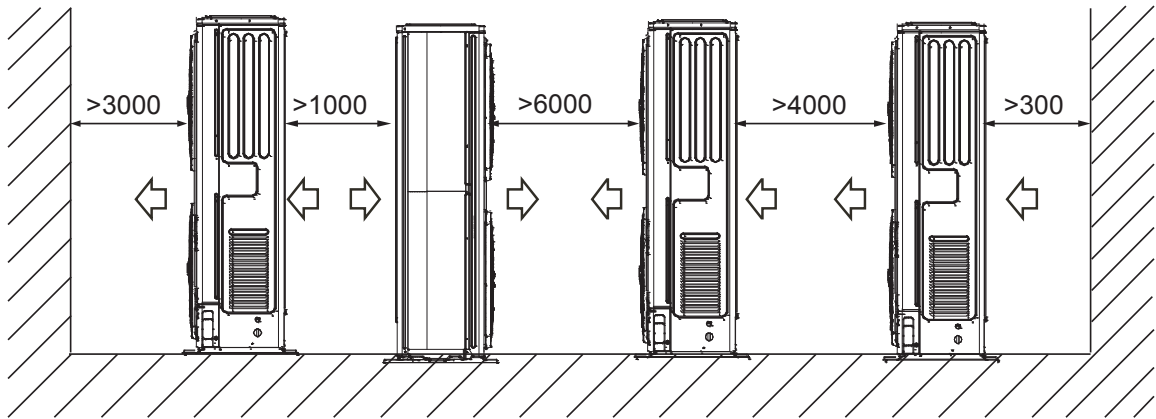

Figure 3-2.9: Parallel connect the front with rear sides



3 Water Pipework

3.1 Water Circuit Checks

Matrix Mono units are equipped with a water inlet and outlet for connection to a water circuit. Matrix Mono units should only be connected to closed water circuits. Connection to an open water circuit would lead to excessive corrosion of the water piping. Only materials complying with all applicable legislation should be used.

Before continuing installation of the unit, check the following:

- The maximum water pressure ≤ 3 bar.
- The maximum water temperature $\leq 70^{\circ}\text{C}$ according to safety device setting.
- Always use materials that are compatible with the water used in the system and with the materials used in the unit.
- Ensure that components installed in the field piping can withstand the water pressure and temperature.
- Drain taps must be provided at all low points of the system to permit complete drainage of the circuit during maintenance.
- Air vents must be provided at all high points of the system. The vents should be located at points that are easily accessible for service. An automatic air purge is provided inside the unit. Check that this air purge valve is not tightened so that automatic release of air in the water circuit is possible.

3.2 Water Volume and Expansion Vessel Pre-pressure Checks

Outdoor units are equipped with an expansion vessel (8L) that has a default pre-pressure of 1.0 bar. To assure proper operation of the unit, the pre-pressure of the expansion vessel might need to be adjusted. Refer to Table 3-3.1. The total volume of water in the system must be at least 25L and should not exceed the limits specified in Figure 3-3.1.

Table 3-3.1: Expansion vessel pre-pressure adjustment

Installation height difference ¹	Water volume ≤ 230 L	Water volume > 230 L
≤ 7 m	No pre-pressure adjustment required	Actions required: <ul style="list-style-type: none"> • Pre-pressure must be decreased, calculate according to "Calculating the pre-pressure of the expansion vessel"² • Check if the water volume is lower than maximum allowed water volume (refer to Figure 3-3.1)
> 7 m	Actions required: <ul style="list-style-type: none"> • Pre-pressure must be increased, calculate according to "Calculating the pre-pressure of the expansion vessel"² • Check if the water volume is lower than maximum allowed water volume (refer to Figure 3-3.1) 	Expansion vessel in the outdoor unit too small for the system. An external expansion vessel (field supplied) is required.

Notes:

1. Height difference is between the highest point of the water circuit and the outdoor unit's expansion tank. Unless the unit is located at the highest point of the system, in which case the installation height difference is considered to be zero.
2. Calculating the pre-pressure of the expansion vessel:
The pre-pressure (Pg) to be set depends on the maximum installation height difference (H) and is calculated as $P_g(\text{bar}) = (H(\text{m}) / 10 + 0.3)$ bar

To determine the maximum allowed water volume in the entire circuit, proceed as follows:

- Determine the calculated pre-pressure (Pg) for the corresponding maximum water volume using the Figure 3-3.1.

Figure 3-3.1: Maximum water volume

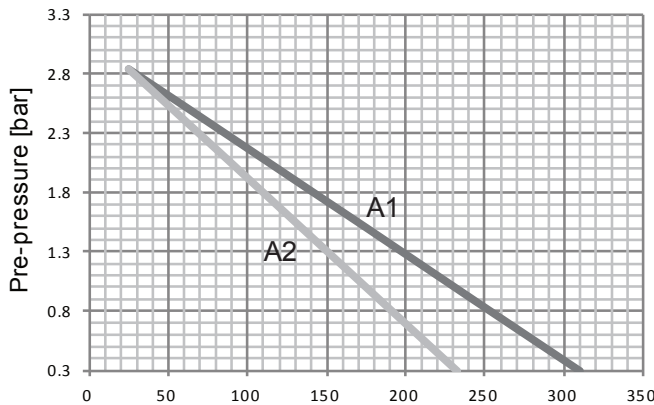

A1: System without glycol

A2: System with 25% propylene glycol

Pre-pressure = pre-pressure of the expansion vessel

Maximum water volume = maximum water volume in the system

- Check that the total water volume in the entire water circuit is lower than this value. If this is not the case, the expansion vessel inside the unit is too small for the installation.

Example 1

The unit is installed 5m below the highest point in the water circuit. The total water volume in the water circuit is 100 L. In this example, no action or adjustment is required. The unit(16kW) is installed at the highest point in the water circuit. The total water volume in the water circuit is 150L.

Example 2

The unit is installed at the highest point in the water circuit. The total water volume in the water circuit is 250L.

Result:

- Since 250 L is more than 230 L, the pre-pressure must be decreased (see table above).
- The required pre-pressure is: $P_g(\text{bar}) = (H(\text{m})/10+0.3) \text{ bar} = (0/10+0.3) \text{ bar} = 0.3 \text{ bar}$
- The corresponding maximum water volume can be read from the graph: approximately 310L.
- Since the total water volume (250L) is below the maximum water volume (310L), the expansion vessel suffices for the installation.

When it is required to change the default pre-pressure of the expansion vessel (1.0 bars), following guidelines:

- Use only dry nitrogen to set the expansion vessel pre-pressure.
- Inappropriate setting of the expansion vessel pre-pressure will lead to malfunctioning of the system. Pre-pressure should only be adjusted by a licensed installer.

If the expansion vessel of unit is too small for the installation, an additional expansion vessel is needed.

- Calculate the pre-pressure of the expansion vessel: $P_g(\text{bar}) = (H(\text{m})/10+0.3) \text{ bar}$
The expansion vessel equipped in the unit should adjust the pre-pressure also.
- Calculate the volume needed of the additional expansion vessel: $V1=0.0693 \cdot V_{\text{water}} / (2.5-P_g) - V0$
 V_{water} : the volume of water in the system
 $V0$: the volume of expansion vessel which the unit is equipped (8L)

3.3 Water Circuit Connection

Water connections must be made correctly in accordance with the labels on the outdoor unit, with respect to the water inlet and water outlet. If air, moisture or dust gets in the water circuit, problems may occur. Therefore, always take into account the following when connecting the water circuit:

- Use clean pipes only.

- Hold the pipe end downwards when removing burrs
- Cover the pipe end when inserting it through a wall to prevent dust and dirt entering.
- Use a good thread sealant for sealing the connections. The sealing must be able to withstand the pressures and temperatures of the system.
- When using non-copper metallic piping, be sure to insulate the two kind of materials from each other to prevent galvanic corrosion.
- For copper is a soft material, use appropriate tools for connecting the water circuit. Inappropriate tools will cause damage to the pipes

3.4 Water Circuit Anti-freeze Protection

Ice formation can cause damage to the hydronic system. As the outdoor unit may be exposed to sub-zero temperatures, care must be taken to prevent freezing of the system. All internal hydronic parts are insulated to reduce heat loss. Insulation must also be added to the field piping.

- The software contains special functions using the heat pump to protect the entire system against freezing. When the temperature of the water flow in the system drops to a certain value, the unit will heat the water, either using the heat pump, the electric heating tap, or the backup heater. The freeze protection function will turn off only when the temperature increases to a certain value.
- In event of a power failure, the above features would not protect the unit from freezing. Since a power failure could happen when the unit is unattended, the supplier recommends use anti-freeze fluid to the water system or install freeze protection valves which can drain the water from the system before it can freeze.
- Anti-freeze fluid
Depending on the expected lowest outdoor temperature, make sure the water system is filled with a concentration of glycol as mentioned in the table below. If the system contains a domestic hot water tank, then only propylene glycol is suitable. If the system does NOT contain a domestic hot water tank, then either propylene glycol or ethylene glycol is OK. When glycol is added to the system, the performance of the unit will be affected. The correction factor of the unit capacity, flow rate and pressure drop of the system is listed in the table 3-3.2 and 3-3.3.

Table 3-3.2: Ethylene Glycol

Concentration of ethylene glycol (%)	Modification coefficient				Minimum outdoor temperature(°C)
	Cooling capacity modification	Power modification	Water resistance	Water flow modification	
0	1.000	1.000	1.000	1.000	0
10	0.984	0.998	1.118	1.019	-5
20	0.973	0.995	1.268	1.051	-15
30	0.965	0.992	1.482	1.092	-25

Table 3-3.3: Propylene Glycol (including the necessary inhibitors, classified as Category III according to EN1717)

Concentration of propylene glycol (%)	Modification coefficient				Minimum outdoor temperature (°C)
	Cooling capacity modification	Power modification	Water resistance	Water flow modification	
0	1.000	1.000	1.000	1.000	0
10	0.976	0.996	1.071	1.000	-4
20	0.961	0.992	1.189	1.016	-12
30	0.948	0.988	1.380	1.034	-20

Uninhibited glycol will turn acidic under the influence of oxygen. This process is accelerated by presence of copper and at higher temperatures. The acidic uninhibited glycol attacks metal surfaces and forms galvanic corrosion cells that cause severe damage to the system. It is of extreme importance:

- That the water treatment is correctly executed by a qualified water specialist.
 - That a glycol with corrosion inhibitors is selected to counteract acids formed by the oxidation of glycols.
 - That in case of an installation with a domestic hot water tank, only the use of propylene glycol is allowed. In other installations the use of ethylene glycol is fine.
 - That no automotive glycol is used because their corrosion inhibitors have a limited lifetime and contain silicates that can foul or plug the system.
 - That galvanized piping is not used in glycol systems since it may lead to the precipitation of certain elements in the glycol's corrosion inhibitor
 - To ensure that the glycol is compatible with the materials used in the system.
- Freeze protection by freeze protection valves
 - When no glycol is added to the water, freeze protection valves can be used to drain the water from the system before it can freeze.
 - Install freeze protection valves (field supply) at all lowest points of the field piping.
 - Normally closed valves (located indoors near the piping entry/exit points) can prevent that all water from indoor piping is drained when the freeze protection valves open.

3.5 Water Flow Switch

Water may enter into the flow switch and cannot be drained out and may freeze when the temperature is low enough. The flow switch should be removed and dried, then can be reinstalled in the unit.

- Counterclockwise rotation, remove the water flow switch.
- Drying the water flow switch completely.

Figure 3-3.2: Water flow switch

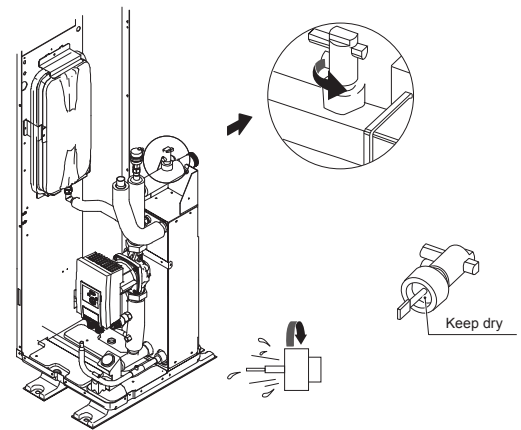

3.6 Adding Water

- Connect the water supply to the fill valve and open the valve.
- Make sure the automatic air purge valve is open (at least 2 turns). Refer to Figure 3-3.3.
- Fill with water until the manometer indicates a pressure of approximately 2.0 bars. Remove air in the circuit as much as possible using the air purge valve. Air in the water circuit could lead to malfunction of the backup electric heater.

Figure 3-3.3: Air purge valve

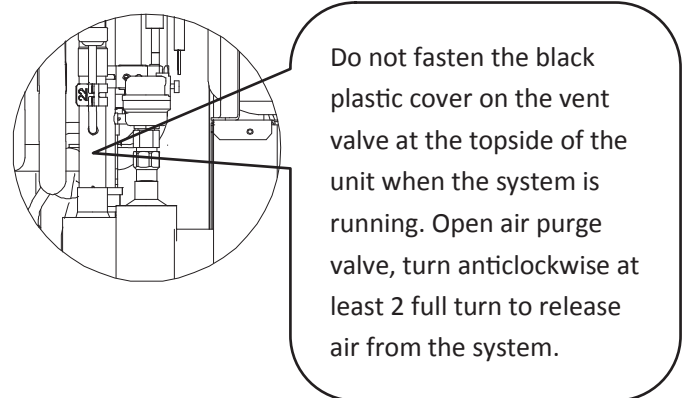

3.7 Water Piping Insulation

The complete water circuit including all piping, water piping must be insulated to prevent condensation during cooling operation and reduction of the heating and cooling capacity as well as prevention of freezing of the outside water piping during winter. The insulation material should at least of B1 fire resistance rating and complies with all applicable legislation. The thickness of the sealing materials must be at least 13mm with thermal conductivity 0.039W/mK in order to prevent freezing on the outside water piping. If the outdoor ambient temperature is higher than 30°C and the humidity is higher than RH 80%, the thickness of the sealing materials should be at least 20mm in order to avoid condensation on the surface of the seal.

4 Electrical Wiring

4.1 General

Notes for installers



Caution

- All installation and wiring must be carried out by competent and suitably qualified, certified and accredited professionals and in accordance with all applicable legislation.
- Electrical systems should be grounded in accordance with all applicable legislation.
- Overcurrent circuit breakers and residual-current circuit breakers (ground fault circuit interrupters) should be used in accordance with all applicable legislation.
- Wiring patterns shown in this data book are general connection guides only and are not intended for, or to include all details for, any specific installation.
- The water piping, power wiring and communication wiring are typically run in parallel. However the communication wiring should not be bound together with power wiring. To prevent signal interference, the power wiring and communication wiring should not be run in the same conduit. If the power supply is less than 10A, a separation of at least 300mm between power wiring and communication wiring conduits should be maintained; if the power supply is in the range 10A to 50A then a separation of at least 500mm should be maintained.

4.2 Precautions

- Fix cables so that cables do not make contact with the pipes (especially on the high pressure side).
- Secure the electrical wiring with cable ties as shown in Figure 3-1.14 and Figure 3-1.15. So that it does not come in contact with the piping, particularly on the high-pressure side.

Figure 3-4.1: Wiring hole locations

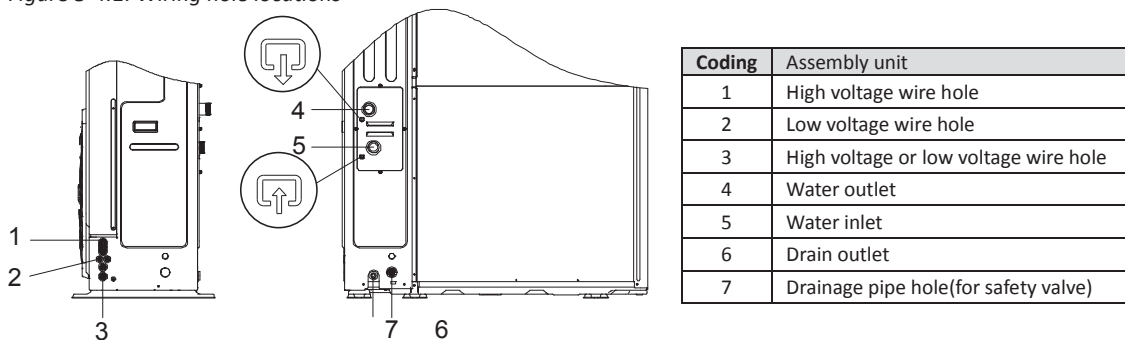

- Make sure no external pressure is applied to the terminal connectors.
- When installing the ground fault circuit interrupter make sure that it is compatible with the inverter (resistant to high frequency electrical noise) to avoid unnecessary opening of the ground fault circuit interrupter.
- This unit is equipped with an inverter. Installing a phase advancing capacitor not only reduce the power factor improvement effect, but also may cause abnormal heating of the capacitor due to high frequency waves. Never install a phase advancing capacitor as it could lead to an accident.

4.3 Guidance

- Most field wiring on the unit is to be made on the terminal block inside the switch box. To gain access to the terminal block, remove the switch box service panel.
- Fix all cables using cable ties.

- A dedicated power circuit is required for the backup electric heater.
- Installation equipped with a domestic hot water tank (field supplied) requires a dedicated power circuit for the immersion heater.
- Lay out the electrical wiring so that the front cover does not rise up when doing wiring work and attach the front cover securely.
- Follow the electric wiring diagrams for electrical wiring works. Refer to Figure 2-4.1 in part 2, 4 “Wiring Diagram”.
- Install the wires and fix the cover firmly so that the cover may be fit in properly.

4.4 Wiring Overview

Figure 3-4.2: Wiring overview

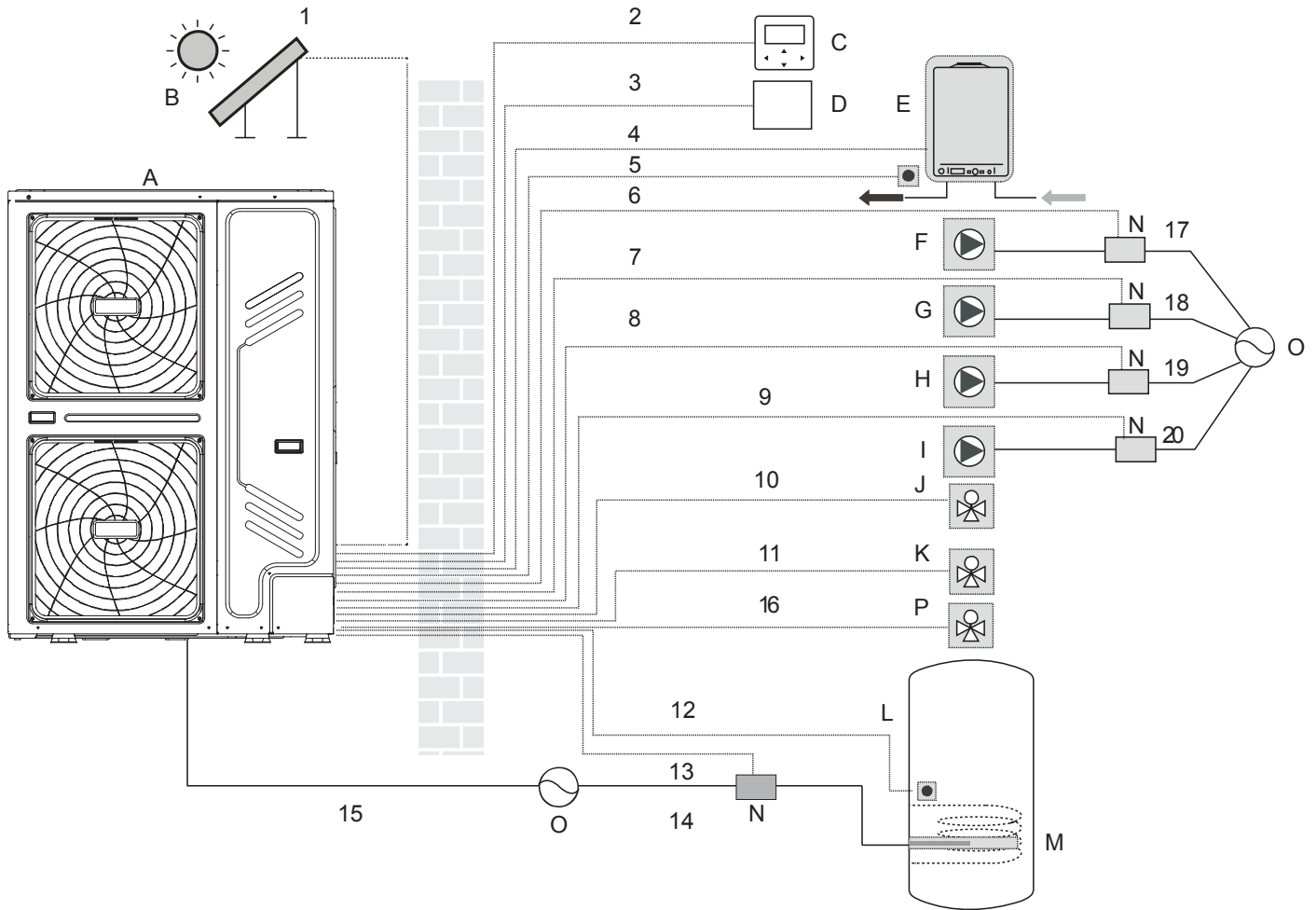

Legend			
A	Outdoor unit	I	P_d: DHW pump (field supplied)
B	Solar panel (field supplied)	J	SV2: 3-way valve (field supplied)
C	Wired controller	K	SV1: 3-way valve for domestic hot water tank(field supplied)
D	Room thermostat (field supplied)	L	Domestic water tank (field supplied)
E	AHS (field supplied)	M	Booster heater (field supplied)
F	P_s: Solar pump (field supplied)	N	Contactor (field supplied)
G	P_c: Circulation pump / zone 2 pump (field supply)	O	Power supply
H	P_o: Outside circulation pump / zone 1 pump (field supply)	P	SV3: 3-way valve for Zone 2 (field supplied)

Table 3-4.1: Wiring requirements

Item	Description	Current	Required number of conductors	Maximum running current
1	Solar energy kit signal wire	AC	2	200mA
2	User interface wire	AC	5	200mA
3	Room thermostat wire	AC	2 or 3	200mA ^a
4	Boiler control wire	/	2	200mA
5	Temperature sensor wire for Tw2	DC	2	b
9	Control wire for DHW PUMP	AC	2	200mA ^a
10	Control wire for 3-way valve	AC	2 or 3	200mA ^a
11	Control wire for 3-way valve	AC	2 or 3	200mA ^a
12	Temperature sensor wire for T5	DC	2	b
13	Control wire for booster heater	AC	2	200mA ^a
15	Power supply wire for outdoor unit	AC	3+GND	c
16	Control wire for 3-way valve	AC	2 or 3	200mA ^a

Notes:

- a. Minimum cable section AWG 18 (0.75mm²)
- b. The temperature sensor wire (10m) are delivered with zone 2 outlet tem. Tw2 and domestic hot water tank T5.
- c. See Table 3-4.2 for details.

Table 3-4.2: Outdoor unit power supply

Unit	18kW	22kW	26kW	30kW
Maximum overcurrent protector(MOP)	18	21	24	28
Wiring size(mm ²)	6	6	6	6

5 DIP Switch Settings

DIP switch is located on the hydraulic module main control board and allows configuration of additional heating source thermistor installation, the second inner backup heater installation, etc.

Table 3-5.1: DIP switch settings

Switch		ON=1	OFF=0	Default factory setting
<p>S1</p>	1	Reserved	Reserved	OFF
	2	Reserved	Reserved	OFF
	3/4	00=Without IBH and AHS 10=With IBH 01=With AHS for heat mode 11=With AHS for heat mode and DHW mode		OFF/OFF
<p>S2</p>	1	Start pumpo after six hours will be invalid	Start pumpo after six hours will be valid	OFF
	2	without TBH	with TBH	OFF
	3/4	00=variable speed pump (Max head:8.5m) 01=constant speed pump 10=variable speed pump(Max head:10.5m) 11=variable speed pump(Max head:9m)		OFF/ON
<p>S4</p>	1/2/3/4	Reserved		OFF
				OFF
				OFF/OFF
<p>S9</p>	1/2	00=Slave unit 11=Master unit		OFF

6 Internal Circulation Pump Speed Settings

The internal circulation pump speed can be selected by adjusting the red knob on the pump. The default factory setting is the highest speed (III). If the system water flow is too high, the pump speed can be set to medium (II) or low (I). The relationship between external static pressure and water flow rate is described in Part 2, 7 “Hydronic Performance”.

Figure 3-6.1: Internal circulation pump

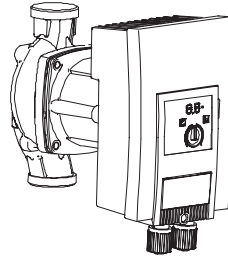

Figure 3-6.2: Faults with external interference sources

Faults	Causes	Remedy
Pump is not running although the power supply is switched on.	Electrical fuse defective.	Check fuses.
Black display.	Pump has no voltage	Restore power after interruption.
Pump is making noises.	Cavitation due to insufficient suction pressure.	Increase the system suction pressure within the permissible range.
		Check the delivery head setting and set to lower head if necessary.

▪ Fault signals

- The fault signal is indicated by the LED display .
- The fault signal LED is continuously illuminated in red .
- The pump switches off (depending on the error code), and attempts a cyclical restart.(Specially, for Error code E10 (blocking): After approx. 10 minutes, the pump switches off permanently and displays the error code.)

Figure 3-6.3: Fault signals

Code No.	Fault	Cause	Remedy
E04	Mains undervoltage	Power supply too low on mains side	Check mains voltage
E05	Mains overvoltage	Power supply too high on mains side	Check mains voltage
E09	Turbine operation	The pump is driven in reverse (the fluid flows through the pump from the pressure to the suction side)	Check flow, install non-return valves if necessary
E10	Blocking	The rotor is blocked	Request customer service
E21*	Overload	Sluggish motor	Request customer service
E23	Short-circuit	Motor current too high	Request customer service
E25	Contacting/winding	Motor winding defective	Request customer service
E30	Module overheated	Module interior too warm	Improve room ventilation, check operating conditions, request customer service, if necessary
E31	Overheated power section	Ambient temperature too high	Improve room ventilation, check operating conditions, request customer service, if necessary
E36	Electronic faults	Electronics defective	Request customer service

* In addition to the LED display, the fault signal LED is continuously illuminated in red.

- Warning signals
 - The warning signal is indicated by the LED display.
 - The fault signal LED and the SSM relay do not respond.
 - The pump continues to run with limited output.
 - The indicated faulty operating status must not occur for a prolonged period. The cause must be eliminated.

Figure 3-6.4: Warning signals

Code No.	Fault	Cause	Remedy
E07	Generator operation	Pump hydraulics have fluid running through them.	Check the system
E11	Dry running	Air in the pump	Check the water volume/ pressure
E21*	Overload	Sluggish motor, pump is operated outside of its specifications (e.g. high module temperature). The speed is lower than during normal operation.	Check the ambient conditions

* In addition to the LED display, the fault signal LED is continuously illuminated in red.

- In order to ensure the service life of the pump, it is recommended that the unit run at least once every 2 weeks (ensure that the pump is running) or keep it powered on for a long time (in the power-on standby state, the unit will run the pump for 3 minutes every 6 hours)

7 User Interface Field Settings

7.1 Introduction

During installation, the Matrix settings and parameters should be configured by the installer to suit the installation configuration, climate conditions and end-user preferences. The relevant settings are accessible and programmable through the **FOR SERVICEMAN** menu on the Matrix user interface. The user interface menus and settings can be navigated using the user interface’s touch-sensitive keys, as detailed in Table 3-7.1.

Figure 3-7.1: User interface

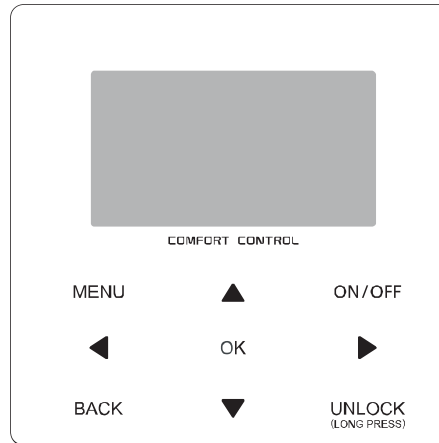
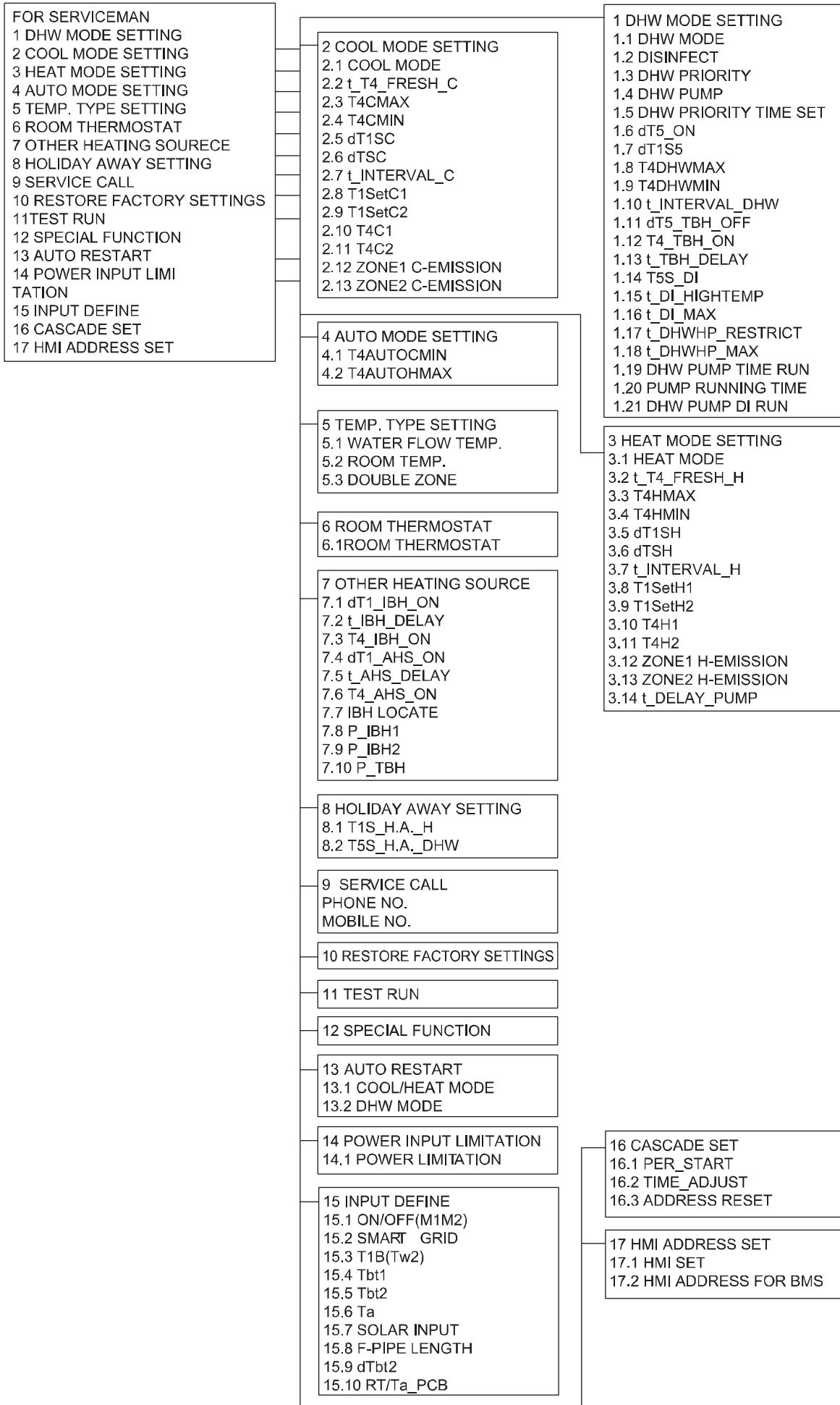

Table 3-7.1: User interface keys

Keys	Function
MENU	<ul style="list-style-type: none"> Go to the menu structure
◀ ▶ ▼ ▲	<ul style="list-style-type: none"> Navigate the cursor on the display Navigate in the menu structure Adjust settings
ON/OFF	<ul style="list-style-type: none"> Turn on/off the space heating/cooling operation or DHW mode Turn on/off functions in the menu structure
BACK	<ul style="list-style-type: none"> Come back to the up level
UNLOCK	<ul style="list-style-type: none"> Long press for unlock/lock the controller Unlock /lock some functions such as “DHW temperature adjusting”
OK	<ul style="list-style-type: none"> Go to the next step when programming a schedule in the menu structure and confirm a selection to enter in the submenu of the menu structure.

7.2 Menu Structure



7.3 FOR SERVICEMAN Menu

FOR SERVICEMAN allows installers to input the system configuration and set the system parameters. To enter **FOR SERVICEMAN**, go to **MENU > FOR SERVICEMAN**.

Enter the password, using ◀ ▶ to navigate between digits and using ▼ ▲ to adjust the numerical values, and then press **OK**. The password is 234. Refer to Figure 3-7.2

Then the following pages will be displayed after putting the password. Refer to Figure 3-7.3

Figure 3-7.2: FOR SERVICEMAN password screen

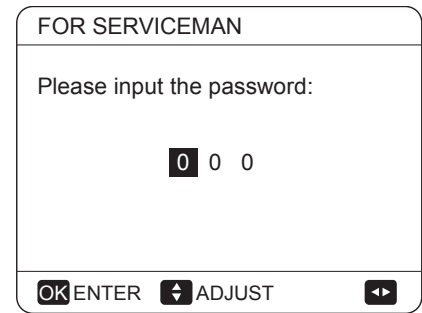

Figure 3-7.3: FOR SERVICEMAN menu

FOR SERVICEMAN 1/3	FOR SERVICEMAN 2/3	FOR SERVICEMAN 3/3
1. DHW MODE SETTING	7. OTHER HEATING SOURCE	13. AUTO RESTART
2. COOL MODE SETTING	8. HOLIDAY AWAY MODE SET	14. POWER INPUT LIMITATION
3. HEAT MODE SETTING	9. SERVICE CALL SETTING	15. INPUT DEFINE
4. AUTO MODE SETTING	10. RESTORE FACTORY SETTINGS	16. CASCADE SET
5. TEMP.TYPE SETTING	11. TEST RUN	17. HMI ADDRESS SET
6. ROOM THERMOSTAT	12. SPECIAL FUNCTION	
OK ENTER	OK ENTER	OK ENTER

7.4 DHW MODE SETTING Menu

7.4.1 DHW MODE SETTING menu overview

MENU > FOR SERVICEMAN > DHW MODE SETTING

Figure 3-7.4: DHW MODE SETTING menu

1 DHW MODE SETTING 1/5	1 DHW MODE SETTING 2/5	1 DHW MODE SETTING 3/5
1.1 DHW MODE YES	1.6 dT5_ON 5 °C	1.11 dT5_TBH_OFF 5 °C
1.2 DISINFECT YES	1.7 dT1S5 10 °C	1.12 T4_TBH_ON 5 °C
1.3 DHW PRIORITY YES	1.8 T4DHWMAX 43 °C	1.13 t_TBH_DELAY 30 MIN
1.4 DHW PUMP YES	1.9 T4DHWMIN -10 °C	1.14 T5S_DI 65 °C
1.5 DHW PRIORITY TIME SET NON	1.10 t_INTERVAL_DHW 5 MIN	1.15 t_DI HIGHTEMP. 15MIN
ADJUST	ADJUST	ADJUST
1 DHW MODE SETTING 4/5	1 DHW MODE SETTING 5/5	
1.16 t_DI_MAX 210 MIN	1.21 DHW PUMP DI RUN NON	
1.17 t_DHWHP_RESTRICT 30 MIN		
1.18 t_DHWHP_MAX 120 MIN		
1.19 DHWPUMP TIME RUN YES		
1.20 PUMP RUNNING TIME 5 MIN		
ADJUST	ADJUST	

In **DHW MODE SETTING** the following parameters should be set.

DHW MODE enables or disables DHW mode. For installations with DHW tanks, select **YES** to enable DHW mode. For installations without DHW tanks, select **NON** to disable DHW mode.

DISINFECT sets whether or not the disinfection operation is performed.

DHW PRIORITY sets whether domestic hot water heating or space heating/cooling takes priority. If **NON** is selected in the **DHW PRIORITY** mode, when it is available and the space heating/cooling is **OFF**, the heat pump will heat the water as required. If space heating/cooling is **ON**, the water will be heated as required when the immersion heater is unavailable.

Only when the space heating/cooling is **OFF** will the heat pump operate to heat domestic water.

DHW PUMP sets whether or not the DHW pump is controlled by the Matrix unit. If the DHW pump is to be controlled by the Matrix, select **YES**. If the DHW pump is not to be controlled by the Matrix unit, select **NON**.

DHW PUMP PRIORITY TIME SET set the operation time of DHW during **DHW PRIORITY** mode.

dT5_ON sets the temperature difference between the DHW set temperature (T5S) and the DHW tank water temperature (T5) above which the heat pump providing heated water to the DHW tank. When $T5S - T5 \geq dT5_ON$ the heat pump providing heated water to the DHW tank.

Note: When the heat pump's leaving water temperature is above the DHW mode leaving water temperature operating limit (T5stop), the heat pump does not provide heated water to the DHW tank. The DHW mode leaving water temperature operating limit is related to ambient temperature as shown in Figure 2-6.3 in Part 2, 6 "Operating Limits".

dT1S5 sets the heat pump's leaving water set temperature (T1S) relative to DHW tank water temperature (T5). For DHW mode, the user sets the DHW set temperature (T5S) on the main screen and cannot manually set T1S. T1S is set as $T1S = T5 + dT1S5$.

Figure 3-7.6 illustrates the operation of the heat pump and immersion heater(optional) in DHW mode. If the DHW tank water temperature (T5) is less than the minimum of the DHW set temperature (T5S) and the heat pump leaving water temperature operating limit (T5stop) (refer to Figure 2-6.3 in Part 2, 6 "Operating Limits") less **dT5_ON**, the heat pump starts providing heated water to the DHW tank. After **t_TBH_delay** minutes have elapsed, the immersion heater is turned on. If T5 reaches T5stop, the heat pump stops but the immersion heater continues running until T5 has reached $T5S + dT5_TBH_OFF$.

Figure 3-7.5: dT5_ON

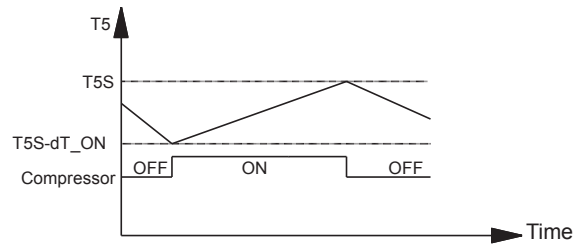

Abbreviations:
 T5: DHW tank water temperature
 T5S: DHW set temperature

Figure 3-7.6: DHW mode operation

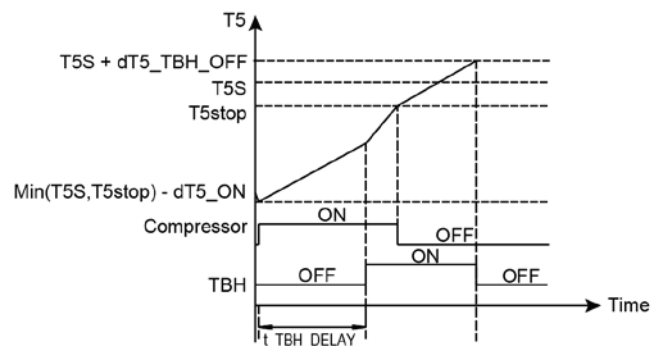

Abbreviations:
 T5: DHW tank water temperature
 T5S: DHW set temperature
 T5stop: DHW mode leaving water temperature operating limit
 TBH: Immersion heater in DHW tank

T4DHWMAX sets the ambient temperature above which the heat pump will not operate in DHW mode. The highest value that **T4DHWMAX** can take is 43°C, which is the DHW mode upper ambient temperature operating limit of the heat pump.

T4DHWMIN sets the ambient temperature below which the heat pump will not operate in DHW mode. The lowest value that **T4DHWMIN** can take is -25°C, which is the DHW mode lower ambient temperature operating limit of the heat pump.

t_INTERVAL_DHW sets the DHW mode compressor re-start delay. When the compressor stops running, it will not re-start

Figure 3-7.7: T4DHWMAX and T4DHWMIN



Abbreviations:
 HP: Heat pump
 TBH: DWH tank immersion heater
 AHS: Additional heating source

until at least **t_INTERVAL_DHW** minutes have elapsed.

dT5_TBH_OFF sets the temperature difference between the DHW set temperature (T5S) and the DHW tank water temperature (T5) below which the immersion is not used. When $T5 > \text{Min}(T5\text{Stop} + dT5_TBH_OFF, 65^\circ\text{C})$, the immersion heater is off.

T4_TBH_ON sets the ambient temperature above which the immersion heater will not be used.

t_TBH_DELAY sets the delay between the compressor starting and the immersion heater being turned on.

T5S_DI sets the DHW tank disinfection operation target temperature. Caution: during the disinfection operation (duration: **t_DI_MAX**) the domestic hot water temperature at the hot water taps will at times be equal to the value set for **T5S_DI**.

t_DI_HIGHTEMP sets that length of time that the DHW tank disinfection operation target temperature is maintained.

t_DI_MAX sets the total duration of the DHW tank disinfect operation.

t_DHWHP_RESTRICT sets the maximum length of time that the heat pump will run in space heating or space cooling modes before switching to DHW mode, if a requirement for DHW mode exists. When running in space heating mode or space cooling mode, the heat pump becomes available for DHW mode either as soon as the space heating/cooling set temperatures have been reached (refer to Part 3, 8.5 "COOL MODE SETTING Menu" and Part 3, 8.6 "HEAT MODE SETTING Menu") or after **t_DHWHP_MAX** minutes have elapsed.

t_DHWHP_MAX sets the maximum length of time that the heat pump will run in DWH mode before switching to space heating mode or space cooling mode if a requirement for space heating/cooling modes exists. When running in DHW mode, the heat pump becomes available for space heating/cooling either as soon as the DHW tank water temperature (T5) reaches the DHW set temperature (T5S) or after **t_DHWHP_MAX** minutes have elapsed.

Figure 3-7.8: DHW tank disinfection

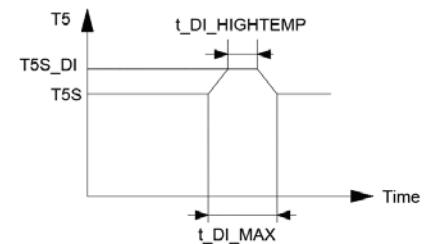

Abbreviations:
 T5: DHW tank water temperature
 T5S: DHW set temperature

Figure 3-7.9 illustrates the effects of **t_DHWHP_MAX** and **t_DHWHP_RESTRICT** when **DHW PRIORITY** is enabled. The heat pump initially runs in DWH mode. After **t_DHWHP_MAX** minutes, T5 has not reached

Figure 3-7.9: Operation in DHW PRIORITY

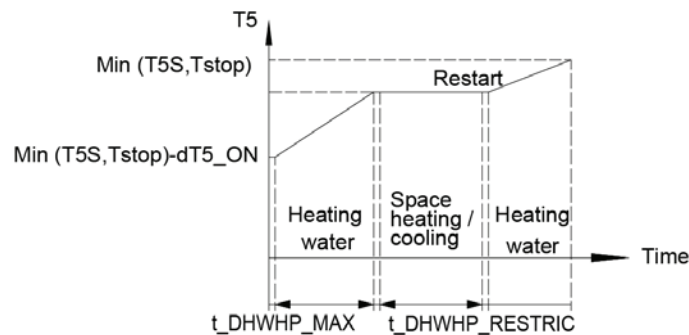

Abbreviations:
 T5: DHW tank water temperature
 T5S: DHW set temperature
 T5stop: DHW mode leaving water temperature operating limit

DHW PUMP TIME RUN sets whether or not the user is able to set the DHW pump (field supply) in DHW mode. For installations with a DHW pump, select ON so that the user is able to set pump start times.

PUMP RUNNING TIME sets the length of time the pump runs for at each of the user-specified start times on the **DHW**

PUMP tab on the DOMESTIC HOT WATER (DHW) menu, if TIMER RUNNING is enabled.

DHW PUMP DI RUN sets whether or not the DHW pump (field supply) operates during the disinfection mode.

7.5 COOL MODE SETTING Menu

MENU > FOR SERVICEMAN > COOL MODE SETTING

Figure 3-7.10: COOL MODE SETTING menu

2 COOL MODE SETTING 1/3	2 COOL MODE SETTING 2/3	2 COOL MODE SETTING 3/3
2.1 COOL MODE YES	2.6 dTSC 2°C	2.11 T4C2 25°C
2.2 t_T4_FRESH_C 2.0HRS	2.7 t_INTERVAL_C 5MIN	2.12 ZONE1 C-EMISSION FCU
2.3 T4CMAX 43°C	2.8 T1SetC1 10°C	2.13 ZONE2 C-EMISSION FLH
2.4 T4CMIN 20°C	2.9 T1SetC2 16°C	
2.5 dT1SC 5°C	2.10 T4C1 35°C	
ADJUST	ADJUST	ADJUST

In COOL MODE SETTING the following parameters should be set.

COOL MODE enables or disables cooling mode. For installations with space cooling terminals, select YES to enable cooling mode. For installations without space cooling terminals, select NON to disable cooling mode.

t_T4_FRESH_C sets the refresh time of cooling model climate temperature curve.

T4CMAX sets the ambient temperature above which the heat pump will not operate in cooling mode. The highest value that T4CMAX can take is 46°C, which is the cooling mode upper ambient temperature operating limit of the heat pump. Refer to Figure 3-7.11.

Figure 3-7.11: T4CMAX, T4CMIN

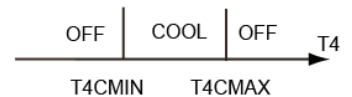

Abbreviations:
T4: Outdoor ambient temperature

T4CMIN sets the ambient temperature below which the heat pump will not operate in cooling mode. The lowest value that T4CMIN can take is -5°C, which is the cooling mode lower ambient temperature operating limit of the heat pump. Refer to Figure 3-7.12.

Figure 3-7.12: dT1SC

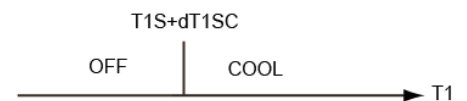

Abbreviations:
T1: Heat pump leaving water temperature
T1S: Heat pump leaving water set temperature

dT1SC sets the minimum temperature difference between the heat pump leaving water temperature (T1) and the heat pump leaving water set temperature (T1S) at which the heat pump provides chilled water to the space cooling terminals. When $T1 - T1S \geq dT1SC$ the heat pump provides chilled water to the space cooling terminals and when $T1 \leq T1S$ the heat pump does not provide chilled water to the space cooling terminals.

dTSC sets the temperature difference between the actual room temperature (Ta) and set room temperature (TS) above which the heat pump provides chilled water to the space cooling terminals. When $Ta - TS \geq dTSC$ the heat pump provides chilled water to the space cooling terminals and when $Ta \leq TS$ the heat pump does not provide chilled water to the space cooling terminals. Refer to Figure 3-7.18. dTSC is only applicable if YES is selected for ROOM TEMP in the TEMP. TYPE SETTING menu. Refer to Part 3, 7.8 “TEMP. TYPE SETTING Menu”.

Figure 3-7.13: dTSC

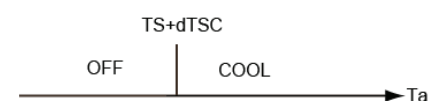

t_INTERVAL_C sets the cooling mode compressor re-start delay. When the compressor stops running, it will not re-start until at least t_INTERVAL_C minutes have elapsed.

T1SetC1 sets the temperature 1 of automatic setting curve for cooling mode.

T1SetC2 sets the temperature 2 of automatic setting curve for cooling mode.

T4C1 sets the ambient temperature 1 of automatic setting curve for cooling mode.

T4C2 sets the ambient temperature 2 of automatic setting curve for cooling mode.

ZONE1 C-EMISSION sets the emission type of zone1 for cooling mode.

ZONE2 C-EMISSION sets the emission type of zone2 for cooling mode.

7.6 HEAT MODE SETTING Menu

MENU > FOR SERVICEMAN > HEAT MODE SETTING

Figure 3-7.14: HEAT MODE SETTING menu

3 HEAT MODE SETTING 1/3	3 HEAT MODE SETTING 2/3	3 HEAT MODE SETTING 3/3
3.1 HEAT MODE YES	3.6 dTSH 2°C	3.11 T4H2 7°C
3.2 t_T4_FRESH_H 2.0HRS	3.7 t_INTERVAL_H 5MIN	3.12 ZONE1 H-EMISSION RAD.
3.3 T4HMAX 16°C	3.8 T1SetH1 35°C	3.13 ZONE2 H-EMISSION FLH
3.4 T4HMIN -15°C	3.9 T1SetH2 28°C	3.14 t_DELAY_PUMP 2MIN
3.5 dT1SH 5°C	3.10 T4H1 -5°C	
ADJUST	ADJUST	ADJUST

In **HEAT MODE SETTING** the following parameters should be set.

HEAT MODE enables or disables heating mode.

t_T4_FRESH_H sets the refresh time of heating mode climate temperature curve.

T4HMAX sets the ambient temperature above which the heat pump will not operate in heating mode. The highest value that **T4HMAX** can take is 35°C, which is the heating mode upper ambient temperature operating limit of the heat pump. Refer to Figure 3-7.15.

Figure 3-7.15: T4HMAX, T4HMIN



Abbreviations:
T4: Outdoor ambient temperature

T4HMIN sets the ambient temperature below which the heat pump will not operate in heating mode. The lowest value that **T4HMIN** can take is -25°C, which is the heating mode lower ambient temperature operating limit of the heat pump. Refer to Figure 3-7.16.

dT1SH sets the temperature difference between the heat pump leaving water temperature (T1) and the heat pump leaving water set temperature (T1S) above which the heat pump provides heated water to the space heating terminals.

Figure 3-7.16: dTSH



Note:
Only when ROOM TEMP is enabled will this function be available

Matrix Mono



dTSH sets the temperature difference between the actual room temperature (T_a) and set room temperature (T_S) above which the heat pump provides heated water to the space heating terminals. When $T_S - T_a \geq dTSH$ the heat pump provides heated water to the space heating terminals and when $T_a \geq T_S$ the heat pump does not provide heated water to the space heating terminals. Refer to Figure 3-7.23. **dTSH** is only relevant if **YES** is selected for **ROOM TEMP** in the **TEMP. TYPE SETTING** menu. Refer to Part 3, 7.8 “TEMP. TYPE SETTING Menu”.

t_INTERVAL_H sets the heating mode compressor re-start delay. When the compressor stops running, it will not re-start until at least **t_INTERVAL_H** minutes have elapsed.

T1SetH1 sets the temperature 1 of automatic setting curve for heating mode.

T1SetH2 sets the temperature 2 of automatic setting curve for heating mode.

T4H1 sets the ambient temperature 1 of automatic setting curve for heating mode.

T4H2 sets the ambient temperature 2 of automatic setting curve for heating mode.

ZONE1 H-EMISSION sets the emission type for heating mode.

ZONE2 H-EMISSION sets the emission type for heating mode.

7.7 AUTO MODE SETTING Menu

MENU > FOR SERVICEMAN > AUTO MODE SETTING

In **AUTO MODE SETTING** the following parameters should be set.

T4AUTOCMIN sets the ambient temperature below which the heat pump will not provide chilled water for space cooling in auto mode. Refer to Figure 3-7.18.

T4AUTOHMAX sets the ambient temperature above which the heat pump will not provide heated water for space heating in auto mode. Refer to Figure 3-7.18.

Figure 3-7.17: AUTO MODE SETTING menu

4 AUTO. MODE SETTING	
4.1 T4AUTOCMIN	25°C
4.2 T4AUTOHMAX	17°C
↕ ADJUST	↔

Figure 3-7.18: T4AUTOHMAX, T4AUTOCMIN

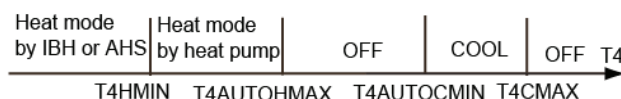

Abbreviations:

HP: Heat pump

AHS: Additional heating source

IBH: Backup electric heater

T4CMAX: The ambient temperature above which the heat pump will not operate in cooling mode.

T4HMIN: The ambient temperature below which the heat pump will not operate in heating mode.

7.8 TEMP. TYPE SETTING Menu

MENU > FOR SERVICEMAN > TEMP. TYPE SETTING

The TEMP. TYPE SETTING is used for selecting whether the water flow temperature or room temperature is used to control the ON/OFF of the heat pump.

When ROOM TEMP. is enabled, the target water flow temperature will be calculated from climate-related curves (refer to “9.1 Climate related curves”).

For installations without room thermostats, space heating and cooling modes can be controlled in one of two different ways:

- according to the Matrix leaving water temperature alone
- according to the room temperature detected by the Matrix user interface’s built-in temperature sensor alone

WATER FLOW TEMP. sets whether space heating/cooling modes are controlled according to the Matrix leaving water temperature. If **YES** is selected, the user is able to set the Matrix unit’s leaving water temperature set temperature on the user interface’s main screen.

Figure 3-7.19: TEMP. TYPE SETTING menu

5 TEMP. TYPE SETTING	
5.1 WATER FLOW TEMP.	YES
5.2 ROOM TEMP.	NON
5.3 DOUBLE ZONE	NON
◀ ADJUST ▶	

Figure 3-7.20: Only set WATER FLOW TEMP to YES

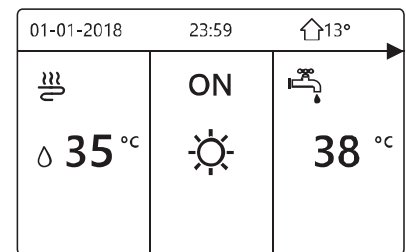

ROOM TEMP. sets whether space heating/cooling modes are controlled according to the room temperature detected by the temperature sensor in the Matrix user interface. If **YES** is selected, the user is able to set the room temperature set temperature on the user interface’s main screen, no matter what is the setting of **WATER FLOW TEMP.**

Figure 3-7.21: Only set ROOM TEMP to YES

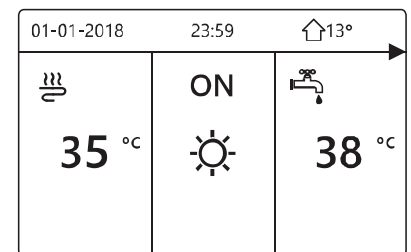

DOUBLE ZONE sets whether there are two zones.

If set WATER FLOW TEMP. and ROOM TEMP. to YES, meanwhile set DOUBLE ZONE to NON or YES, the following pages will be displayed. In this case, the setting value of zone 1 is T1S, the setting value of zone 2 is T1S2 (The corresponding T1S2 is calculated according to the climate related curves.)

Figure 3-7.22: Set WATER FLOW TEMP. and ROOM TEMP. to YES; Set DOUBLE ZONE to NON or YES

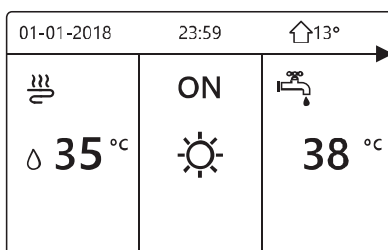

Homepage (zone 1)

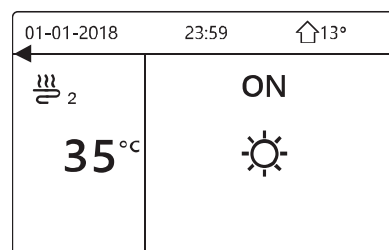

Addition page (zone 2)
(Double zone is effective)

Matrix Mono



If set DOUBLE ZONE to YES and set ROOM TEMP. to NON, meanwhile set WATER FLOW TEMP. to YES or NON, the following pages will be displayed. In this case, the setting value of zone 1 is T1S, the setting value of zone 2 is T1S2.

Figure 3-7.23: Set DOUBLE ZONE to YES and set ROOM TEMP. to NON; Set WATER FLOW TEMP. to YES or NON



Homepage (zone 1)

Addition page (zone 2)

If set DOUBLE ZONE and ROOM TEMP. to YES, meanwhile set WATER FLOW TEMP. to YES or NON, the following page will be displayed. In this case, the setting value of zone 1 is T1S, the setting value of zone 2 is T1S2. (The corresponding T1S2 is calculated according to the climate related curves.)

Figure 3-7.24: Set DOUBLE ZONE and ROOM TEMP. to YES; Set WATER FLOW TEMP. to YES or NON



Homepage (zone 1)

Addition page (zone 2)
(Double zone is effective)

7.9 ROOM THERMOSTAT Menu

MENU > FOR SERVICEMAN > ROOM THERMOSTAT

As an alternative to controlling space heating/cooling modes according to the Matrix unit's leaving water temperature and/or the room temperature detected by the temperature sensor in the Matrix user interface, separate room thermostat can be installed and used to control space heating/cooling modes.

In **ROOM THERMOSTAT** the following parameters should be set.

ROOM THERMOSTAT sets whether or not room thermostats are installed. For installations with room thermostats, select **YES**. For installations without room thermostats, select **NON**.

ROOM THERMOSTAT = NON: No room thermostat.

ROOM THERMOSTAT = MODE SET: Room thermostat can control heating and cooling individually.

ROOM THERMOSTAT=ONE ZONE: Room thermostat provides the switch signal to unit.

ROOM THERMOSTAT=DOUBLE ZONE: Indoor unit is connected with two room thermostat.

Figure 3-7.25: ROOM THERMOSTAT menu

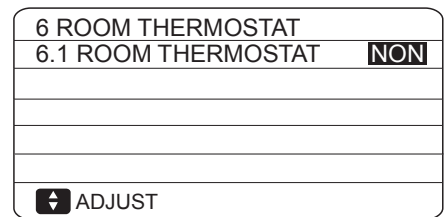

7.10 OTHER HEATING SOURCE Menu

7.10.1 OTHER HEATING SOURCE menu overview

MENU > FOR SERVICEMAN > OTHER HEATING SOURCE

Figure 3-7.26: OTHER HEATING SOURCE menu

7 OTHER HEATING SOURCE 1/2	7 OTHER HEATING SOURCE 2/2
7.1 dT1_IBH_ON 5°C	7.6 T4_AHS_ON 5°C
7.2 t_IBH_DELAY 30MIN	7.7 IBH LOCATE PIPE LOOP
7.3 T4_IBH_ON -5°C	7.8 P_IBH1 0.0kW
7.4 dT1_AHS_ON 5°C	7.9 P_IBH2 0.0kW
7.5 t_AHS_DELAY 30MIN	7.10 P_TBH 2.0kW
ADJUST	ADJUST

In **OTHER HEATING SOURCE** the following parameters should be set. Backup electric heater is optional.

dT1_IBH_ON sets the temperature difference between the heat pump’s leaving water set temperature (T1S) and the heat pump’s leaving water temperature (T1) above which the backup electric heater heating element(s) are on. When $T1S - T1 \geq dT1_IBH_ON$ the backup electric heater is on (on models where the backup electric heater has a simple on/off control function).

t_IBH_DELAY sets the delay between the compressor starting and the backup electric heater being turned on.

T4_IBH_ON sets the ambient temperature below which the backup electric heater is used. If the ambient temperature is above **T4_IBH_ON**, the backup electric heater is not used. The relationship between operation of the backup heater and the ambient is shown in Figure 3-7.22.

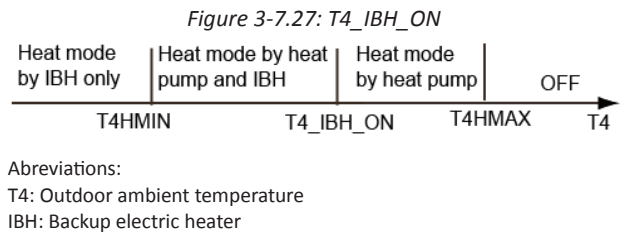

dT1_ASH_ON sets the temperature difference between the heat pump’s leaving water set temperature (T1S) and the heat pump’s leaving water temperature (T1) above which the additional heating source is on. When $T1S - T1 \geq dT1_ASH_ON$ the additional heating source is on.

t_ASH_DELAY sets the delay between the compressor starting and the additional heating source being turned on.

T4_AHS_ON sets the ambient temperature below which the additional heating source is used. If the ambient temperature is above **T4_AHS_ON**, the additional heating source is not used. The relationship between operation of the additional heating source and the ambient is shown in the picture below.

Figure 3-7.28: T4_AHS_ON

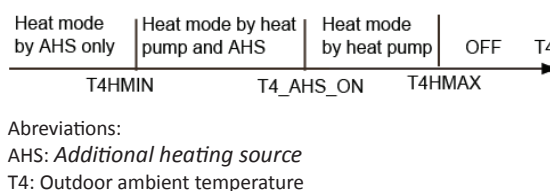

IBH LOCATE means IBH is installed for pipe heating.

P_IBH1, P_IBH2 set heating capacity of IBH and **P_TBH** sets heating capacity of TBH, which are used for energy consumption statistics.

7.11 HOLIDAY AWAY SETTING Menu

MENU > FOR SERVICEMAN > HOLIDAY AWAY SETTING

The **HOLIDAY AWAY SETTING** menu settings are used to set the outlet water temperature to prevent water pipes freezing when away from home in cold weather seasons. In **HOLIDAY AWAY SETTING** the following parameters should be set.

T1S_H.A._H sets the heat pump's leaving water set temperature for space heating mode when in holiday away mode.

T5S_H.A._DHW sets the heat pump's leaving water set temperature for DHW mode when in holiday away mode.

Figure 3-7.29: HOLIDAY AWAY SETTING menu

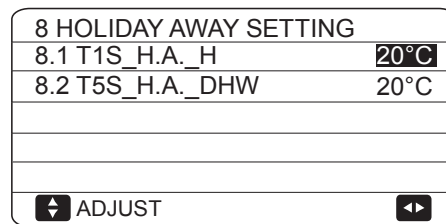

7.12 SERVICE CALL Menu

MENU > FOR SERVICEMAN > SERVICE CALL

In **SERVICE CALL** the following parameters can be set.

PHONE NO. and **MOBILE NO.** can be used to set after-sales service contact numbers. If set, these numbers are displayed to users in **MENU > FOR SERVICEMAN > SERVICE CALL**

Use ▼ ▲ to adjust the numerical values. The maximum length of the phone numbers is 14 digits.

Figure 3-7.30: SERVICE CALL menu

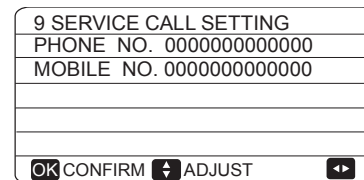

The black rectangle found between 0 and 9 when scrolling up and down using ▼ ▲ is converted to a blank space when the phone numbers are displayed to users in **MENU > FOR SERVICEMAN > SERVICE CALL** and can be used for phone numbers less than 14 digits in length.

7.13 RESTORE FACTORY SETTINGS

MENU > FOR SERVICEMAN > RESTORE FACTORY SETTINGS

RESTORE FACTORY SETTINGS is used to restore all the parameters set in the user interface to their factory defaults.

On selecting **YES**, the process of restoring all settings to their factory defaults begins and progress is displayed as a percentage.

Figure 3-7.31: RESTORE FACTORY SETTINGS screens

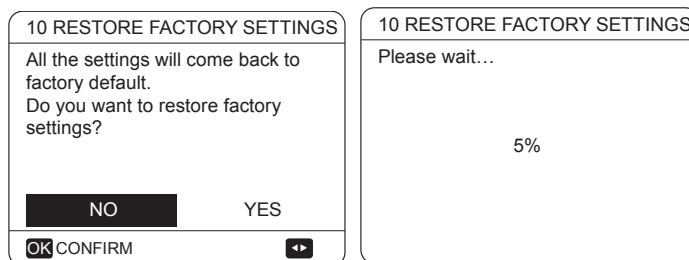

7.14 TEST RUN

7.14.1 TEST RUN Menu overview

MENU > FOR SERVICEMAN > TEST RUN

TEST RUN is used to check that the valves, air purge function, circulation pump, space cooling mode, space heating mode and DHW mode are all operating correctly.

Figure 3-7.32: TEST RUN start screen and TEST RUN menu

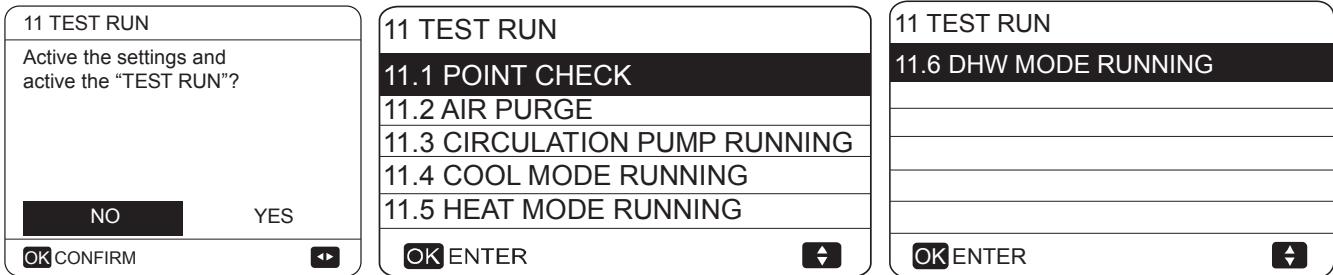

During test run, all buttons except OK are invalid. If you want to turn off the test run, please press OK. For example ,when the unit is in air purge mode, after you press OK, the following page will be displayed:

Figure 3-7.33: Exit air purge screen

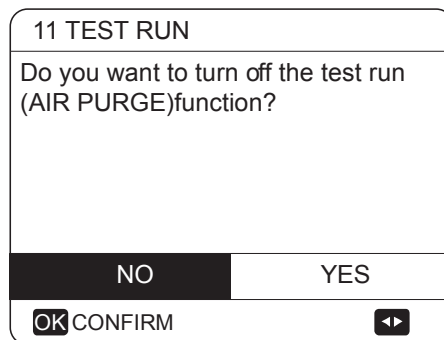

7.14.2 POINT CHECK menu

MENU > FOR SERVICEMAN > TEST RUN > POINT CHECK

The **POINT CHECK** menu is used to check the operation of individual components. Use ▼▲ to scroll to the components you want to check and press ON/OFF to toggle the on/off state of the component. If a valve does not turn on/off when its on/off state is toggled or if a pump/heater does not operate when turned on, check the component’s connection to the hydronic system main PCB.

Figure 3-7.34: POINT CHECK menu

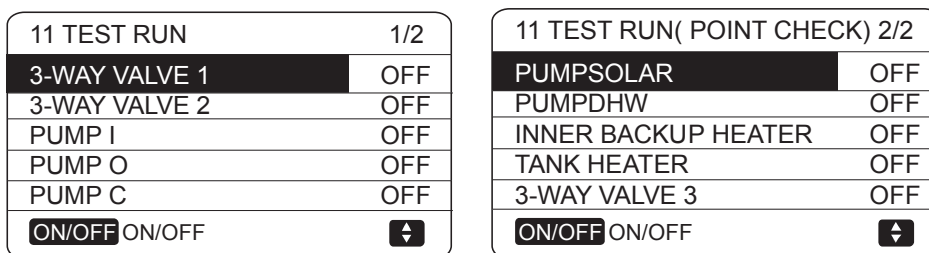

7.14.3 AIR PURGE operation

MENU > FOR SERVICEMAN > TEST RUN > AIR PURGE

Once installation is complete it is important to run the air purge function to remove any air which may be present in the water piping and which could cause malfunctions during operation.

The **AIR PURGE** operation is used to remove air from the water piping. Before running AIR PURGE mode, make sure that the air purge valve is open. When the air purge operation starts, the 3-way valve opens and the 2-way valve closes. 60 secs later the pump in the unit (PUMPI) operates for 10min during which the flow switch does not work. After the pump stops, the 3-way valve closes and the 2-way valve opens. 60 secs later both PUMPI and PUMPO operate until the next command is received. If any error code is displayed during the air purge operation, the cause should be investigated. Refer to Part 3, 9.2 "Error Code table".

Figure 3-7.35: AIR PURGE operation

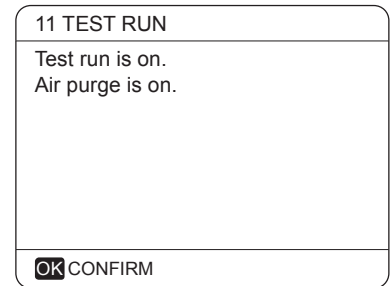

7.14.4 CIRCULATION PUMP RUNNING operation

MENU > FOR SERVICEMAN > TEST RUN > CIRCULATION PUMP RUNNING

The **CIRCULATION PUMP RUNNING** operation is used to check the operation of the circulation pump. When the circulation pump running operation starts, all running components stop. 60 secs later, SV1 opens and SV2 closes. After a further 60 secs PUMPI starts. 30 seconds later, if the flow switch detects that the water flow is normal, PUMPI operates for 3 min. After the pump stops 60s, the SV1 closes and SV2 opens. 60s later both PUMI and PUMPO will operate. After a further 2 min the flow switch start to check the water flow. If the water flow rate is sufficient, both PUMPI and PUMPO operate until the next command is received. If the water flow rate is insufficient over any 15-second period, PUMPI and PUMPO stop and error code E8 is displayed. Refer to Part 3, 8.2 "Error Code table".

Figure 3-7.36: CIRCULATION PUMP RUNNING display

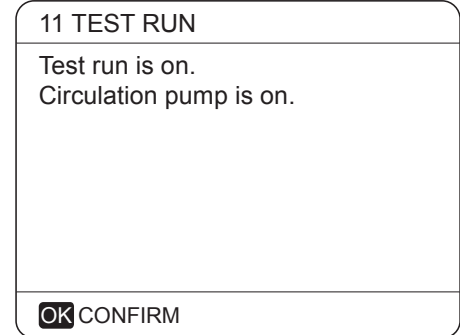

7.14.5 COOL MODE RUNNING operation

MENU > FOR SERVICEMAN > TEST RUN > COOL MODE RUNNING

The **COOL MODE RUNNING** operation is used to check the operation of the system in space cooling mode.

During the **COOL MODE RUNNING** operation, the Matrix unit leaving water set temperature is 7°C. The current actual leaving water temperature is displayed on the user interface. The unit operates until the leaving water temperature drops to the set temperature or the next command is received.

Figure 3-7.37: COOL MODE RUNNING display

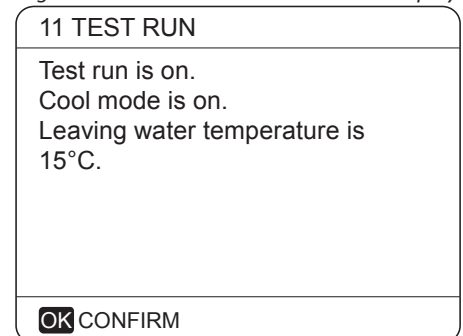

If any error code is displayed during the cool mode running operation, the cause should be investigated. Refer to Part 3, 8.2 "Error Code table".

7.14.6 HEAT MODE RUNNING operation

The **HEAT MODE RUNNING** operation is used to check the operation of the system in space heating mode.

During the **HEAT MODE RUNNING** operation the Matrix unit leaving water set temperature is 35°C. The current actual leaving water temperature is displayed on the user interface. When the **HEAT MODE RUNNING** operation starts, the heat pump first runs for 10 mins.

Figure 3-7.38: HEAT MODE RUNNING display

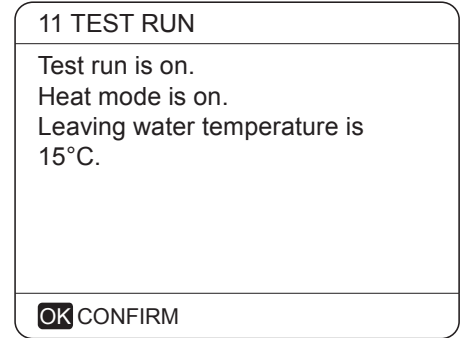

After 10 mins:

- On systems where an auxiliary heat source (AHS) is installed, the AHS starts and runs for 10 mins (whilst the heat pump continues running), after which the AHS stops and the heat pump continues to operate until the water temperature rises to the set temperature or the heat mode running operation is exited by pressing **OK**.
- On systems where a backup electric heater is being used, the backup heater turn on (on models where the backup heater has a simple on/off control function). 3 mins later the backup electric heater will turn off. The heat pump will then operate until the water temperature rises to the set temperature or the **next command is received**.
- On systems with no auxiliary heat source (AHS), the heat pump will then operate until the water temperature rises to the set temperature or the **next command is received**.

If any error code is displayed during the cool mode running operation, the cause should be investigated. Refer to Part 3, 8.2 "Error Code table".

7.14.7 DHW MODE RUNNING operation

The **DHW MODE RUNNING** operation is used to check the operation of the system in DHW mode.

During the **DHW MODE RUNNING** operation, the DHW set temperature is 55°C. On systems where a tank boost heater is installed, the tank boost heater will turn on once the heat pump has run for 10 mins. The tank boost heater will turn off 3 min later and the heat pump will operate until the water temperature rises to the set temperature or the **next command is received**.

Figure 3-7.39: DHW MODE RUNNING display

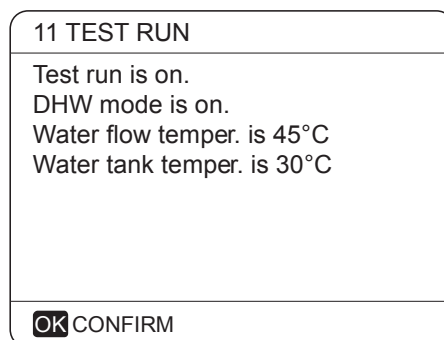

7.15 SPECIAL FUNCTION

7.15.1 SPECIAL FUNCTION menu overview

MENU > FOR SERVICEMAN > SPECIAL FUNCTION

SPECIAL FUNCTION is used to pre-heating floor and drying up floor once installation is complete or the first time start up the unit or restart the unit after a long time stop.

Figure 3-7.40: Special functions menu

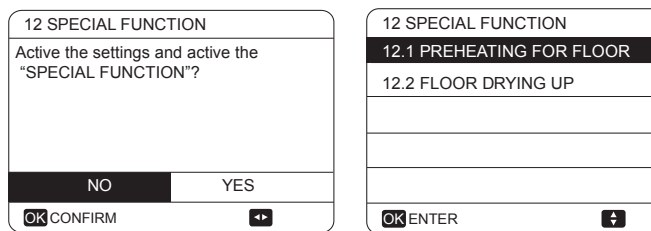

7.15.2 PREHEATING FOR FLOOR

MENU > FOR SERVICEMAN > SPECIAL FUNCTION > PREHEATING FOR FLOOR

Before floor heating, if a large amount of water remains on the floor, the floor may be warped or even rupture during floor heating operation, in order to protect the floor, floor drying is necessary, during which the temperature of the floor should be increased gradually.

During first operation of the unit, air may remain in the water system which can cause malfunctions during operation. It is necessary to run the air purge function to release the air (make sure the air purge valve is open).

T1S sets the heat pump's leaving water set temperature in preheating for floor mode.

t_fristFH sets the duration of preheating for floor mode.

The operation of the unit during preheating for floor mode is illustrated in Figure 3-7.50.

Figure 3-7.41: Preheating for floor menu

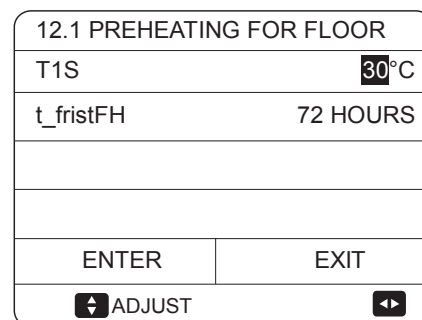
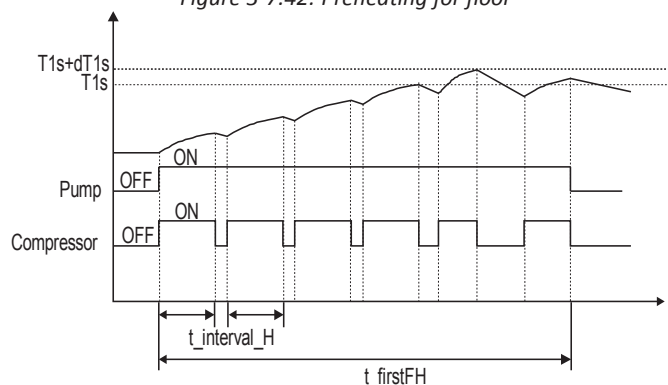

Figure 3-7.42: Preheating for floor



Abbreviations:
 t_interval_H: Compressor re-start delay in space heating mode. (Refer to Part 3, 8.6 "HEAT MODE SETTING Menu").

Whilst the preheating for floor operation is running, the number of minutes that it has been running for and the heat pump's leaving water temperature are displayed on the user interface. During the preheating for floor operation all buttons except **OK** are inactivated. To exit the preheating for floor operation, press **OK** and then select **YES** when prompted. Refer to Figure 3-7.38.

Figure 3-7.43: Preheating for floor screens

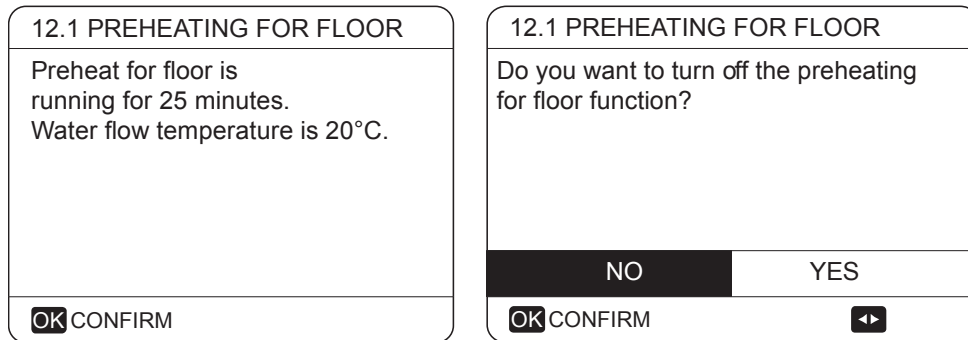

7.15.3 FLOOR DRYING UP

MENU > FOR SERVICEMAN > SPECIAL FUNCTION > FLOOR DRYING UP

For newly-installed under-floor heating systems, floor drying up mode can be used to remove moisture from the floor slab and subfloor to prevent warping or rupture of the floor during floor heating operation. There are three phases to the floor drying up operation:

- Phase 1: gradual temperature increase from a starting point of 25°C to the peak temperature
- Phase 2: maintain peak temperature
- Phase 3: gradual temperature decrease from the peak temperature to 45°C

t_DRYUP sets the duration of Phase 1.

t_HIGHPEAK sets the duration of Phase 2.

t_DRYDOWN is the duration of Phase 3.

T_DRYPEAK sets the heat pump's leaving water set temperature for Phase 2.

START TIME sets the floor drying up operation start time.

START DATE sets the floor drying up operation start date.

The heat pump's leaving water set temperature during the floor drying up operation is illustrated in Figure 3-7.40.

During the floor drying up operation all buttons except **OK** are inactivated. To exit the floor drying up operation, press **OK** and then select **YES** when prompted.

Note: In the event of a heat pump malfunction, floor drying up mode will continue if a backup electric heater and/or additional heating source is available and configured to support space heating mode.

Figure 3-7.44: FLOOR DRYING UP menu

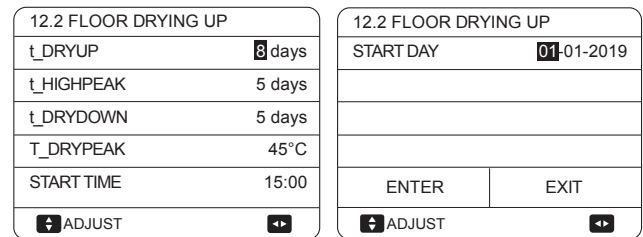

Figure 3-7.45: FLOOR DRYING UP settings

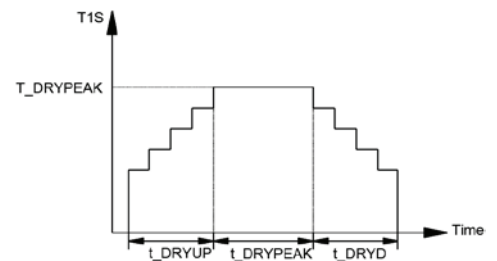
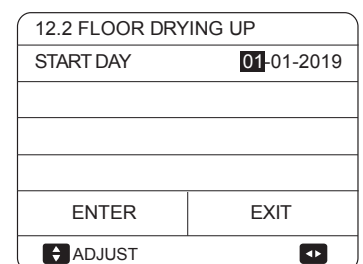

Figure 3-7.46: FLOOR DRYING UP screen



Matrix Mono

7.16 AUTO RESTART

MENU > FOR SERVICEMAN > AUTO RESTART

AUTO RESTART sets whether or not the unit re-applies the user interface settings when the power returns following a power failure. Select **YES** to enable auto restart or **NON** to disable auto restart.

If the auto restart function is enabled, when the power returns following a power failure, the unit re-applies the user interface settings from before the power failure. If the auto restart function is disabled, when the power returns after a power failure, the unit won't auto restart.

Figure 3-7.47: AUTO RESTART menu

13 AUTO RESTART	
13.1 COOL/HEAT MODE	YES
13.2 DHW MODE	NON
ADJUST	

7.17 POWER INPUT LIMITATION

MENU > FOR SERVICEMAN > POWER INPUT LIMITATION

POWER INPUT LIMITATION sets the type of power input limitation and the setting range is 0-8. If the unit will operate at larger power input, 0 should be selected. If the unit will operate at a lower power input, 1-8 should be selected and the power input and capacity will decrease.

Figure 3-7.48: POWER INPUT LIMITATION menu

13 AUTO RESTART	
13.1 COOL/HEAT MODE	YES
13.2 DHW MODE	NON
ADJUST	

Figure 3-7.49: Limitation value (unit:A)

Model \ No.	0	1	2	3	4	5	6	7	8
18kW	18	18	17	16	15	14	13	12.5	12
22kW	21	21	20	19	18	17	16	15	14
26kW	24	24	23	22	21	20	19	18	17
30kW	28	28	27	26	25	24	23	22	21

7.18 INPUT DEFINE

MENU > FOR SERVICEMAN > INPUT DEFINE

INPUT DEFINE sets sensors and functions to fulfill with installation.

ON/OFF(M1M2) sets the control function of M1M2 for remote ON/OFF of unit or AHS of TBH

SMART GRID sets whether SMART GRID control signal is connected to hydronic PCB.

T1B sets whether T1B sensor exist in the installation.

Tbt1, Tbt2 set whether balance tank temperature sensors are installed in the balance tank. (Tbt1: upper temp. sensor, Tbt2: nether temp. sensor)

Ta sets the Ta sensor connection type (HMI: Ta on wired controller; IDU: Ta connected on hydronic PCB)

SOLAR INPUT sets whether solar control signal is connected to hydronic PCB.

F-PIPE LENGTH sets the length of refrigerant pipes between outdoor unit and indoor unit.

dTbt2 sets the temperature difference for starting the unit.

RT/Ta_PCB sets whether hydronic adapter board is valid.

Figure 3-7.50: INPUT DEFINE

15 INPUT DEFINE	
15.1 ON/OFF(M1M2)	REMOTE
15.2 SMART GRID	NO
15.3 T1B(Tw2)	NO
15.4 Tbt1	NO
15.5 Tbt2	HMI
ADJUST	

15 INPUT DEFINE	
15.6 Ta	HMI
15.7 SOLAR INPUT	NON
15.8 F-PIPE LENGTH	<10m
15.9 dTbt2	12°C
15.10 RT/Ta_PCB	NON
ADJUST	

7.19 CASCADE SET

MENU > FOR SERVICEMAN > CASCADE SET

Figure 3-7.51: CASCADE SET

16 CASCADE SET	
16.1 PER_START	20%
16.2 TIME_ADJUST	5 MIN
16.3 ADDRESS RESET	FF
 ADJUST	

PER_START sets the start-up percentage of multiple units.

TIME_ADJUST sets the judgment period of adding and subtracting units

ADDRESS RESET resets the address code of unit.("FF" is an invalid address code.) After setting the address, you need to press the "UNLOCK" key to confirm.

7.20 HMI ADDRESS SET

MENU > FOR SERVICEMAN > HMI ADDRESS SET

Figure 3-7.52: HMI ADDRESS SET

17 HMI ADDRESS SET	
HMI SET	MASTER
HMI ADDRESS FOR BMS	0
 ADJUST	

HMI SET sets the wired controller is master or slave. (0=MASTER, 1=SLAVE)

When HMI SET is set to SLAVE, the controller can only switch the operation mode, turn on or off, set the temperature, and cannot set other parameters and functions.

HMI ADDRESS FOR BMS sets the HMI address code for BMS.(only valid for master controller)

8 Operation parameter

MENU > OPERATION PARAMETER

This menu is for installer or service engineer reviewing the operation parameters. There are nine pages for the operating parameter as following

Figure 3-8.1: Operation parameter

OPERATION PARAMETER	#01
ONLINE UNITS NUMBER	1
OPERATE MODE	COOL
SV1 STATE	ON
SV2 STATE	OFF
SV3 STATE	OFF
PUMP_I	ON
ADDRESS	1/9

OPERATION PARAMETER	#01
PUMP-O	OFF
PUMP-C	OFF
PUMP-S	OFF
PUMP-D	OFF
PIPE BACKUP HEATER	OFF
TANK BACKUP HEATER	ON
ADDRESS	2/9

OPERATION PARAMETER	#01
GAS BOILER	OFF
T1 LEAVING WATER TEMP.	35°C
WATER FLOW	1.72m ³ /h
HEAT PUMP CAPACTIY	11.52kW
POWER CONSUM.	1000kWh
Ta ROOM TEMP	25°C
ADDRESS	3/9

OPERATION PARAMETER	#01
T5 WATER TANK TEMP.	53°C
Tw2 CIRCUIT2 WATER TEMP.	35°C
TIS' C1 CLIMATE CURVE TEMP.	35°C
TIS2' C2 CLIMATE CURVE TEMP.	35°C
TW_O PLATE W-OUTLET TEMP.	35°C
TW_I PLATE W-OUTLET TEMP.	30°C
ADDRESS	4/9

OPERATION PARAMETER	#01
Tbt1 BUFFERTANK_UP TEMP.	35°C
Tbt2 BUFFERTANK_LOW TEMP.	35°C
Tsolar	25°C
IDU SOFTWARE	01-09-2019V01
ADDRESS	5/9

OPERATION PARAMETER	#01
ODU MODEL	6kW
COMP.CURRENT	12A
COMP.FREQUENCY	24Hz
COMP.RUN TIME	54 MIN
COMP.TOTAL RUN TIME	1000Hrs
EXPANSION VALVE	200P
ADDRESS	6/9

OPERATION PARAMETER	#01
FAN SPEED	600R/MIN
IDU TARGET FREQUENCY	46Hz
FREQUENCY LIMITED TYPE	5
SUPPLY VOLTAGE	230V
DC GENERATRIX VOLTAGE	420V
DC GENERATRIX CURRENT	18A
ADDRESS	7/9

OPERATION PARAMETER	#01
TW_O PLATE W-OUTLET TEMP.	35°C
TW_I PLATE W-INLET TEMP.	30°C
T2 PLATE F-OUT TEMP.	35°C
T2B PLATE F-IN TEMP.	35°C
Th COMP. SUCTION TEMP.	5°C
Tp COMP. DISCHARGE TEMP.	75°C
ADDRESS	8/9

OPERATION PARAMETER	#01
T3 OUTDOOR EXCHARGE TEMP.	5°C
T4 OUTDOOR AIR TEMP.	5°C
TF MODULE TEMP.	55°C
P1 COMP. PRESSURE	2300kPa
ODU SOFTWARE	01-09-2018V01
HMI SOFTWARE	01-09-2018V01
ADDRESS	9/9

9 Network Configuration Guidelines

The wired controller realizes intelligent control with a built-in WIFI module, which receives control signal from the APP. Before connecting the WLAN, please check for it if the router in your environment is active and make sure that the wired controller is well-connected to the wireless signal. When the product is connected to the network, please make sure that the phone is as close as possible to the product. Inventor only supports 2.4GHz band routers at present. Special characters (punctuation, spaces, etc.) are not recommended as part of the WLAN name. It is recommended that you connect no more than 10 devices to a single router lest home appliances are affected by weak or unstable network signal. If the password of the router or WLAN is changed, clear all settings and reset the appliance. APP interface changes from time to time as APP is updated and may change slightly vary from those in this document.

9.1 Install APP

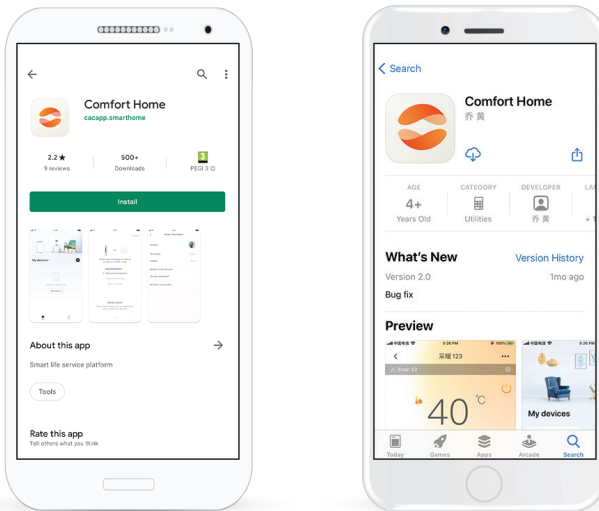

Step 1. Android: Visit Android Store and download “Comfort Home” App
 iOS: Visit iOS app store and download “Comfort Home” App

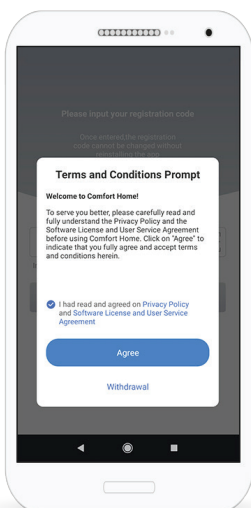

Step 2. Open app & accept the notifications pop up. Read the Privacy Policy and User Agreement and select Agree to continue.

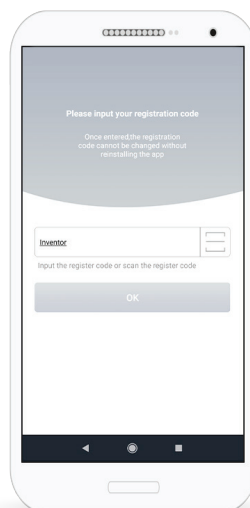

Step 3. Insert “Inventor” for the registration code. Press ok to continue.

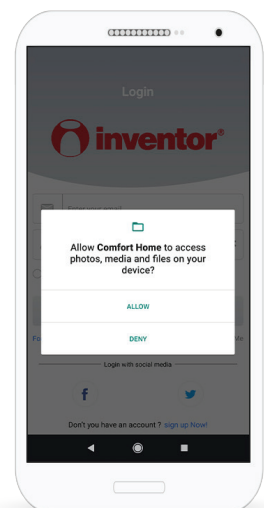

Step 4. Allow access to the pop ups (location/storage/photos).

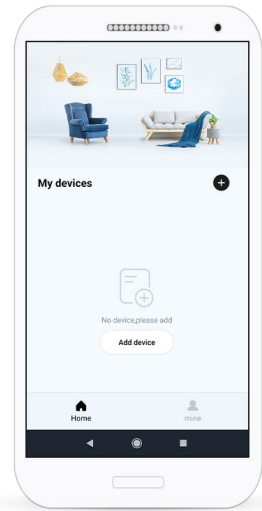
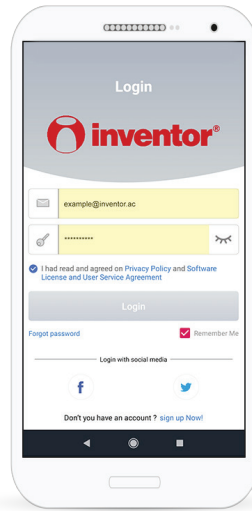
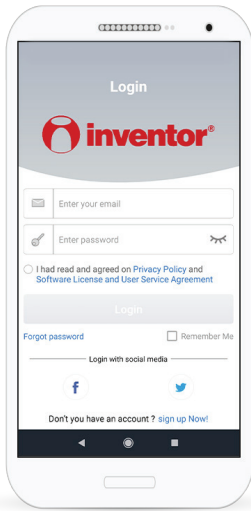

Step 5. Select “sign up” to create a new account. Input the confirmation code that is sent to your email to complete the registration.

Step 6. Login with your account.

Step 7. Select “add device” or the “+” icon on the top right corner to add a new device.

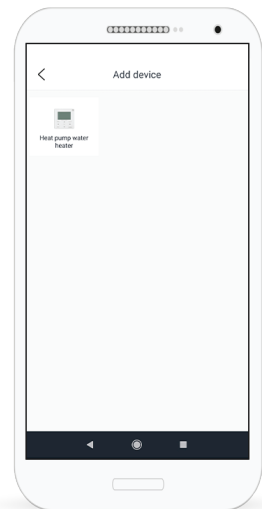
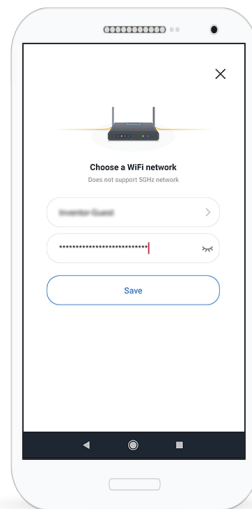
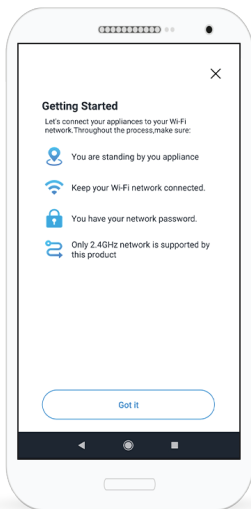

Step 8. Make sure you are near the heat pump and the wifi router. Keep your mobile/tablet connected to your wifi and make sure you have your wifi password ready. Make sure that your wifi is set at 2.4 GHz. Select “Got it” to proceed.

Step 9. Select your wifi and insert your wifi password. Press “save” to continue.

Step 10. Select the “Heat Pump water heater”

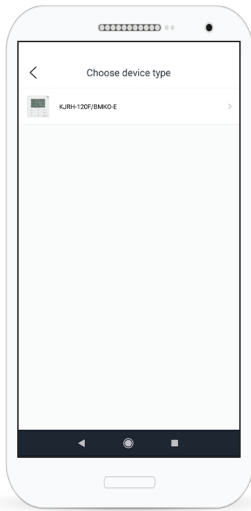

Step 11. Select the “KJRH-120F/ BMKO-E”

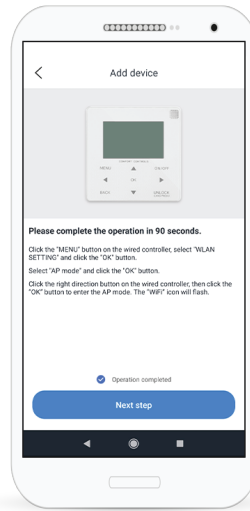

Step 12. On the wired controller, select “MENU”, then “WLAN SETTING” and press “OK”. Select “AP mode” and press ok. Click once the right button to selecty the “OK” command, and please “OK” to enter the WiFi mode. The WiFi icon on the wired controller will start flashing. Make sure you complete the operation in 90 seconds after the icon starts flashing. Check the “Operation completed on the bottom part of the screen of the mobile/tablet, and select the “Next step” to continue”.

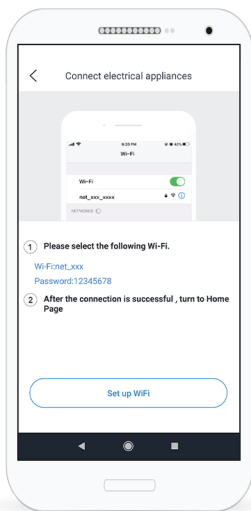

Step 13. Select “Set up WiFi” to find and connect to the heat pump’s WiFi.

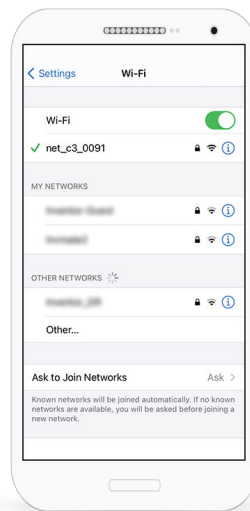

Step 14. In your “device’s wifi networks, find the net_xx_xxxx network and press to connect. The password is “12345678”.

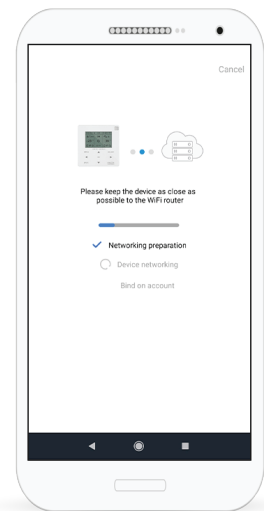

Step 15. Once connected to the device’s wifi, return to the APP. The process will automatically proceed. Allow for a few minutes for the process to complete.

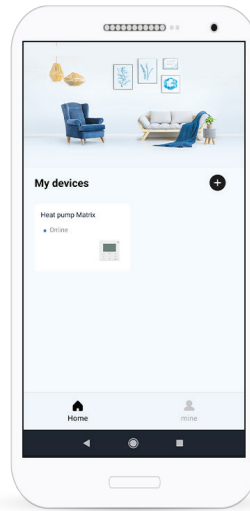
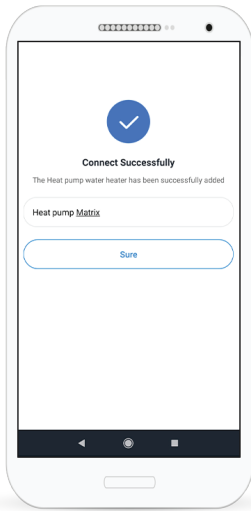

Step 16. When the process is completed, you can select the unit's name. Select "Confirm" to finish the process.

Step 17. The unit is connected.

10 USB function guidelines

10.1 Parameters setting transfer between wired controllers

Installer can quickly copy the wired controller parameter settings from unit A to unit B via USB disk, which save the time of on-site installation. Steps are as follows:

Step 1:

Plug U disk into the port of hydronic PCB of A unit.

“USB” appears on digital display

Wired controller interface automatically changes

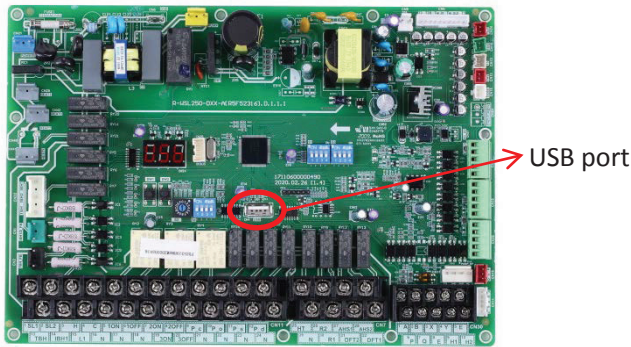

USB FUNCTION
READ SET PARAMETER
WRITE SET PARAMETER
OK ↕

Step 2:

Select “READ SET PARAMETER” and press “OK” button then rate of progress will appear. When the process is finished, “SUCCESS” appears below and an EXCEL file which can not be seen in the wired controller interface but users can find it on computer will be generated inside the USB disk.

Select “READ SET PARAMETER”

Finished

EXCEL generated

USB FUNCTION
READ SET PARAMETER 63%
WRITE SET PARAMETER
OK ↕

USB FUNCTION
READ SET PARAMETER
WRITE SET PARAMETER
OK SUCCESS ↕

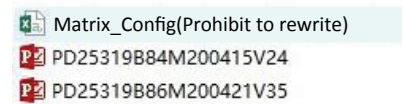

After that, if parameter correction is needed, please connect the USB with computer and open the EXCEL file to change parameters and then save it. Please do not change the file name or format. Parameters are not allowed for non-professionals to change and Inventor recommends to use the wired controller to change the parameters.

Step 3:

Plug USB disk into the port of hydronic PCB of B unit and select “WRITE SET PARAMETER” then rate of progress will appear. When the process is finished, “SUCCESS” appears below.

Select “WRITE SET PARAMETER”

Finished

USB FUNCTION
READ SET PARAMETER
WRITE SET PARAMETER 25%
OK ↕

USB FUNCTION
READ SET PARAMETER
WRITE SET PARAMETER
OK SUCCESS ↕

11 Appendix

11.1 Environment Temperature Curves

The climate related curves can be selected in the user interface, **MENU > PRESET TEMPERATURE > WEATHER TEMP. SET.**

The curves for heating mode and ECO heating mode are the same but the default curve is curve 4 in heating mode, while in ECO mode, the default curve is curve 6. The default curves for cooling mode is curve 4. Once the curve is selected, the leaving water set temperature (T1s) is determined by the outdoor temperature. In each mode, each curve from the eight curves in the user interface can be selected. The relationship between outdoor ambient temperature (T4) and leaving water set temperature (T1s) is described as in Figure 3-11.2, Figure 3-11.3, Figure 3-11.4 and Figure 3-11.5.

Figure 3-11.1: WEATHER TEMP.SET menu

PRESET TEMPERATURE		
PRESET TEMP.	WEATHER TEMP.SET	ECO MODE
ZONE1 C-MODE LOW TEMP.		OFF
ZONE1 H-MODE LOW TEMP.		OFF
ZONE2 C-MODE LOW TEMP.		OFF
ZONE2 H-MODE LOW TEMP.		OFF
ON/OFF ON/OFF		

The automatic setting curves are the ninth curve for cooling and heating mode, the ninth curve can be set as in Figure 3-11.6 and Figure 3-11.7.

Figure 3-11.2: Low temperature curves for heating mode¹

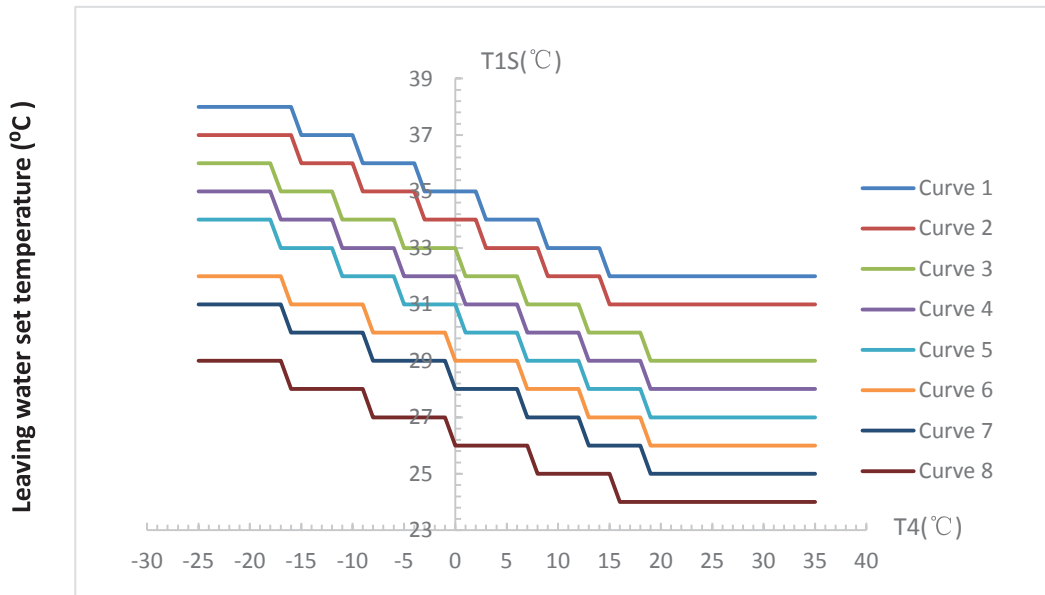

Notes:

1. It only has the curves of the low temperature setting for heating, if the low temperature is set for heating.
2. Curve 4 is default in low temperature heating mode and curve 6 is default in ECO mode.

Figure 3-11.3: High temperature curves for heating mode¹

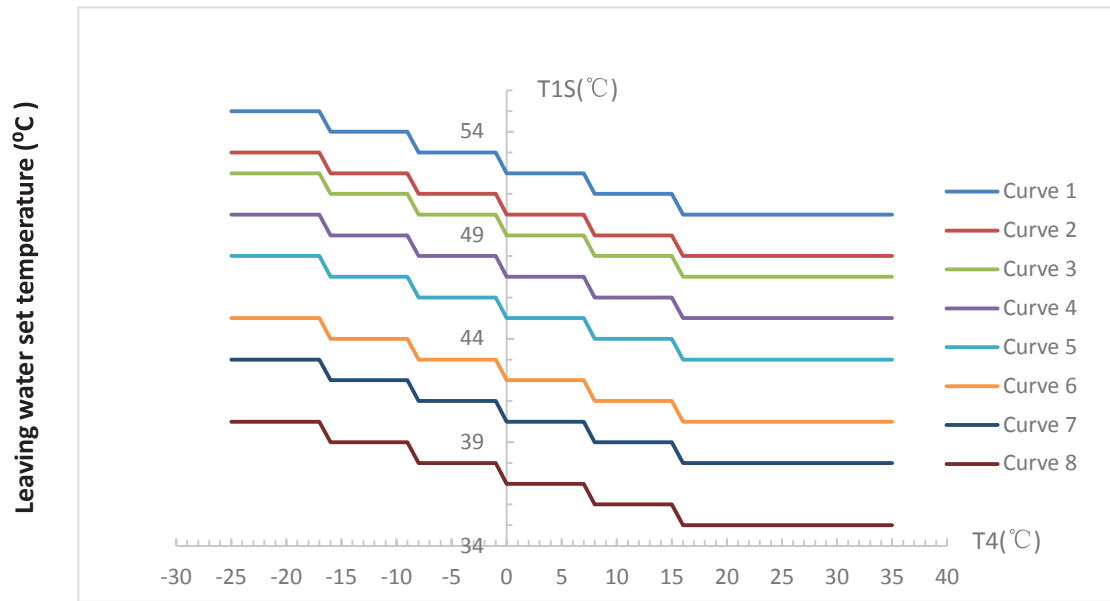

Notes:

1. It only has the curves of the high temperature setting for heating, if the high temperature is set for heating.
2. Curve 4 is default in high temperature heating mode and curve 6 is default in ECO mode.

Figure 3-11.4: Low temperature curves for cooling mode¹

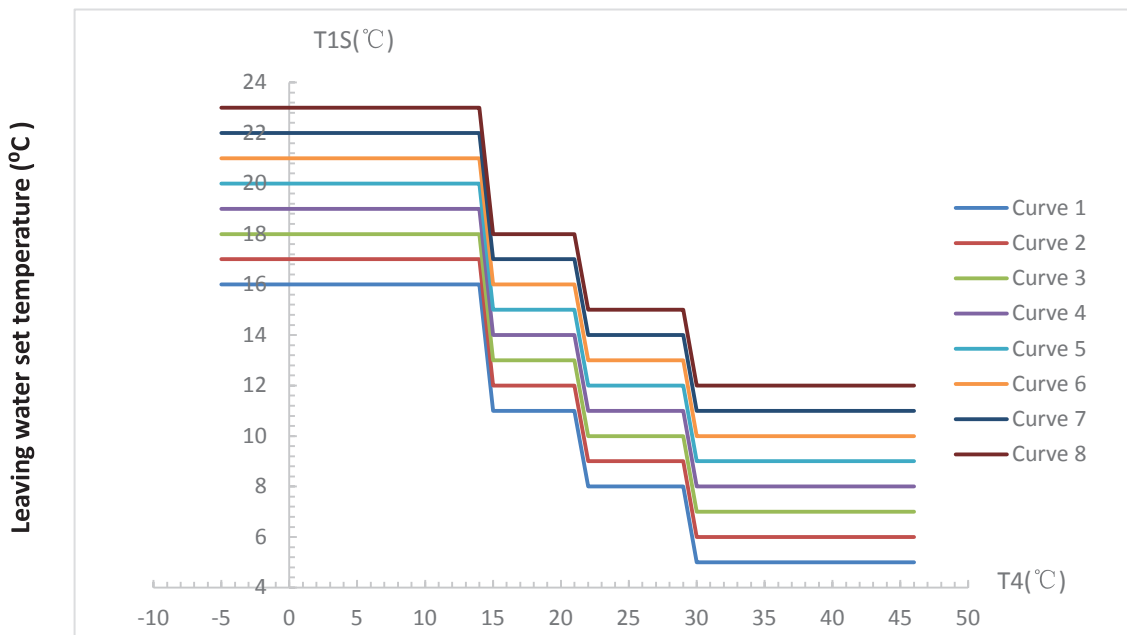

Notes:

1. It only has the curves of the low temperature setting for cooling, if the low temperature is set for cooling.
2. Curve 4 is default in low temperature cooling mode.

Figure 3-11.5: High temperature curves for cooling mode¹

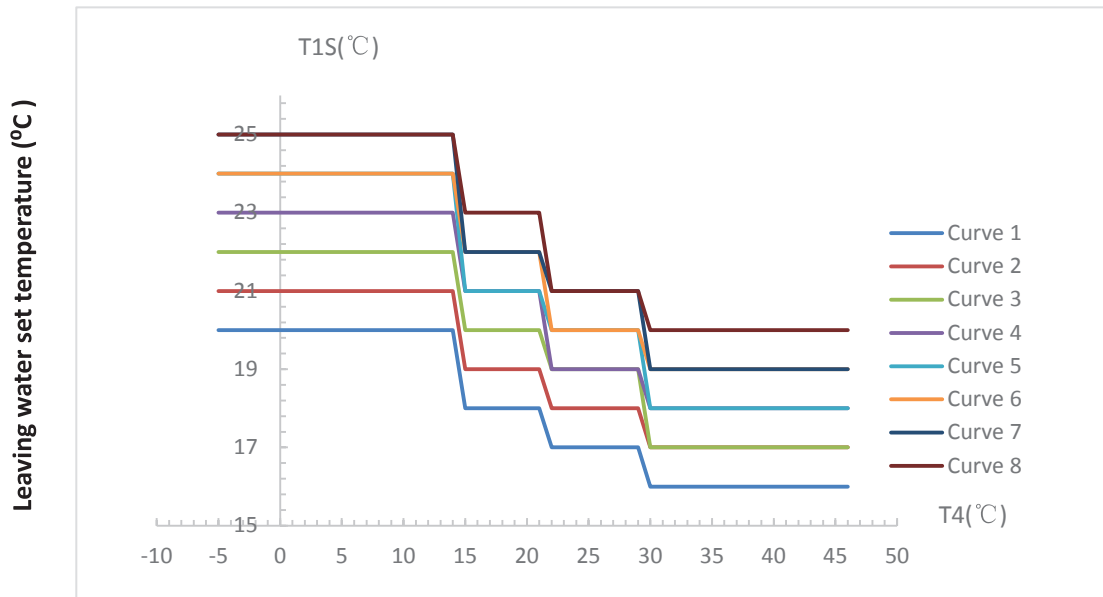

Notes:

1. It only has the curves of the high temperature setting for cooling, if the high temperature is set for cooling.
2. Curve 4 is default in high temperature cooling mode.

Figure 3-11.6: Automatic setting curve for heating mode

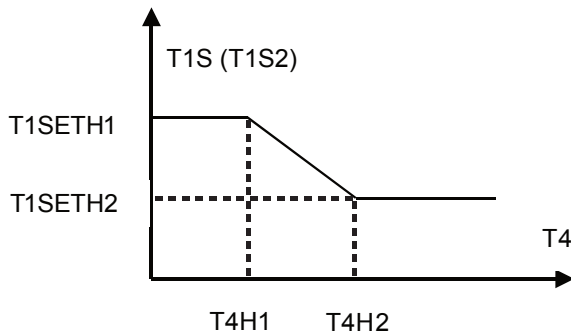
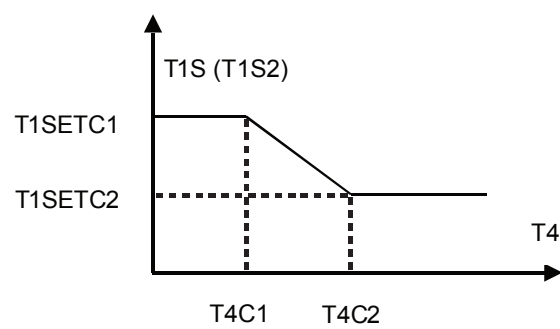

Figure 3-11.7: Automatic setting curve for cooling mode



The setting of T1SETH1, T1SETH2, T4H1, T4H2 refer to Part 3, 8.6" HEATING MODE SETTING Menu" and T1SETC1, T1SETC2, T4C1, T4C2 refer to Part 3, 8.5" COOLING MODE SETTING Menu".

12 Error Code Table

Table 3-12.1: Error code table

Error code	Content ²
bH	PED PCB fault
C7	High temp. protection of inverter module
E0	Water flow fault (E8 displayed 3 times)
E1	Phase loss or neutral wire and live wire are connected reversely (only for three phase unit)
E2	Communication fault between controller and main control board of hydraulic module
E3	Final outlet water temp. sensor (T1) fault.
E4	Water tank temp. sensor (T5) fault.
E5	The condenser outlet refrigerant temperature sensor (T3) fault
E6	The ambient temperature sensor (T4) fault.
E7	The balance tank up temp. sensor (Tbt1) fault.
E8	Water flow fault.
E9	Compressor suction temp. sensor (Th) fault.
EA	Compressor discharge temp. sensor (Tp) fault
Eb	Solar panel temp.sensor (Tsolar) fault.
Ec	The balance tank low temp.sensor(Tbt2) fault
Ed	The plate exchanger water inlet temp. sensor (Tw_in) fault.
EE.	The main control board of hydraulic module EEPROM fault.
F1	DC bus low voltage protection
H0	Communication fault between main control board of hydraulic module and main control board PCB B(Main control board of unit)
H1	Communication fault between inverter module PCB A(Inverter module) and main control board PCB B(Main control board of unit)
H2	The plate exchanger refrigerant outlet (liquid pipe) temp. sensor (T2) fault
H3	The plate exchanger refrigerant outlet (gas pipe) temp. sensor (T2B) fault.
H4	Three times P6 protection
H5	Room temp. sensor (Ta) fault
H6	DC fan motor fault.
H7	Main circuit voltage protection fault
H8	Pressure sensor fault.
H9	Zone 2 water flow temp. sensor (Tw2) fault.
HA	The plate heat exchanger water outlet temperature sensor (Tw_out) fault.
Hb	Three times “PP” protection and Tw_out<7℃
Hd	Communication fault between master unit and slave unit (in parallel)
HE	Communication fault between indoor unit and Ta / room thermostat transfer PCB.
HF	Inverter module board EE PROM fault
HH	H6 displayed 10 times in 120 minutes.
HP	Low pressure protection (Pe<0.6) occurred 3 times in 1 hour in cooling mode
P0	Low pressure protection
P1	High pressure protection
P3	Compressor overcurrent protection
P4	Compressor discharge temp. too high protection
P5	High Temperature difference protection between water inlet and water outlet of the plate heat exchanger.

P6	Inverter module protection
Pb	Anti-freeze mode protection
Pd	High temperature protection of refrigerant outlet temp. of condenser
PP	Water inlet temperature is higher than water outlet in heating mode
L0	DC compressor inverter module fault
L1	DC bus low voltage protection (from inverter module mostly when compressor running)
L2	DC bus high voltage protection from DC driver
L4	MCE fault
L5	Zero speed protection
L7	Phase sequence fault
L8	Compressor frequency variation greater than 15Hz within 1 second protection
L9	Actual compressor frequency differs from target frequency by more than 15Hz protection

Note: Product specifications change from time to time as product improvements and developments are released and may vary from those in this document.



AIR CONDITIONING SYSTEMS

AIR TO WATER HEAT PUMPS - MONOBLOCK



V 1.0 112021

Manufacturer: **INVENTOR A.G. S.A.**

24th km National Road Athens - Lamia & 2 Thoukididou Str., Ag.Stefanos, 14565

Tel.: +30 211 300 3300, Fax: +30 211 300 3333 - www.inventor.ac

